



**Manfrotto**

PROFESSIONAL  
PHOTO SUPPORTS



## Manfrotto mission

### The question.

What do I need to take the perfect photo?

# PA IMAGING SUPPORT

With more than 38 years of tradition,

Manfrotto has been building the world's widest range system of products for the imaging world.

Manfrotto mission is to offer professional support solutions aimed at the photographic, video and live entertainment market, supporting your imaging passion.

Innovative, stylish and user-friendly design, high quality materials and manufacturing processes, solid, reliable, iconic, patented and unique products that no other brand can offer.

Every product in our range is designed in collaboration with professional users in order to provide a perfect combination of key features such as load capacity, size, stability, transportability, interchangeability.

Manfrotto: complete professional imaging support solutions inspired and crafted by Italian creativity.

USER FRIENDLY  
PASSIONATE  
MAESTRO  
USER FRIENDLY  
WOW FACTOR  
CONSISTENTLY  
WOW FACTOR  
PASSIONATE

**The answer.**

Manfrotto.

Complete professional imaging support system inspired and crafted by Italian creativity.



# Manfrotto System

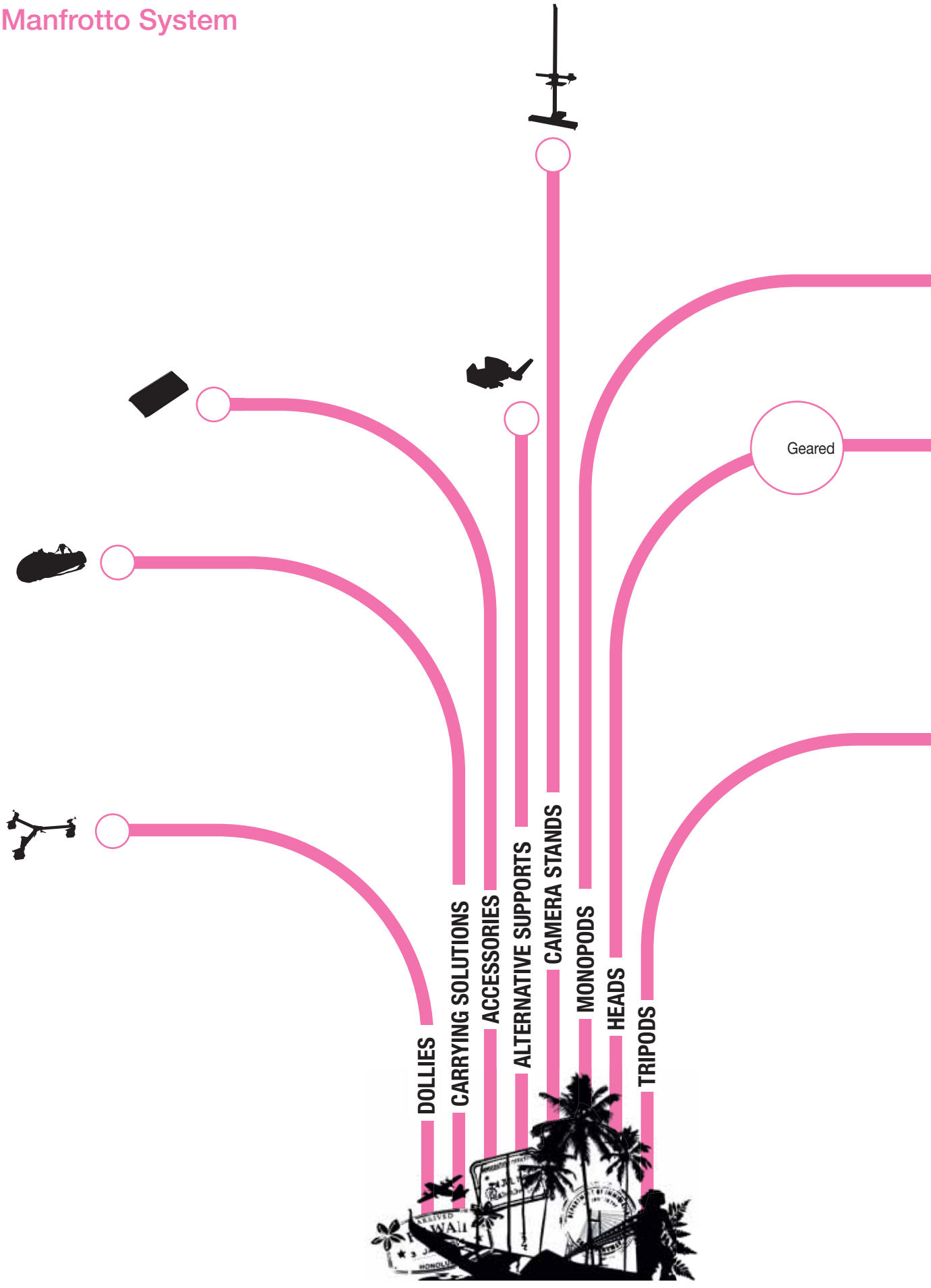

The Manfrotto photographic system is more than a wide range of products: it's a real system of professional photo solutions supporting you, in every condition.

A full range of tripods, heads, accessories, alternative supports, dollies, bags: just make your choice and select the perfect combination, considering the desired features in terms of payload, lightness, speed and precision, to get the perfect kit and equipment you need.

Manfrotto, a real system of solutions able to support you and your photographic passion.



3-Way

Ball

Joystick

VR

2-Way



Studio

Neotec

X

M-Y



Contents

11	<b>TRIPODS</b>
37	<b>HEADS</b>
71	<b>MONOPODS</b>
79	<b>DOLLIES</b>
83	<b>ALTERNATIVE SUPPORTS</b>
95	<b>ACCESSORIES</b>
105	<b>CARRYING SOLUTIONS</b>
111	<b>CAMERA STANDS</b>
124	<b>INDEX</b>

# How to choose your camera support system



Considering your camera equipment and your specific needs related to the photography type, a balanced choice between tripod and head is the first fundamental step. The best choice is a balance among camera, tripod and head features and the photographer's specific needs.

## 1) CONSIDER YOUR CAMERA WEIGHT

The first thing to consider before selecting tripod + head is the camera weight.

Please remember to select a system balanced with the weight of your camera. Don't forget also to consider the lens you are using.

For example, using long lenses, the center of gravity of your camera will have a greater offset than using a normal lens, and this could require extra stability from your tripod and head.

In this case you could consider to choose a system with an higher max load capacity, being sure you have maximized the stability of your supporting system.

### CAMERA WEIGHT

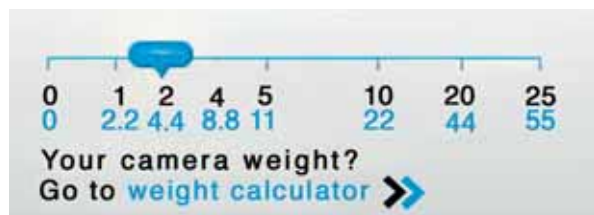

## 2) CALCULATE THE SYSTEM MAX LOAD CAPACITY

If you want to evaluate the max load for the system (tripod + head), please consider the min value between tripod max load and head max load capacity (note: don't forget that the tripod has to carry not only the camera but also the head).



Maximum load capacity



### 3) CONSIDER YOUR SPECIFIC NEEDS

The Manfrotto heads/tripods range includes products with different features, materials, max height, closed length, weight, max load, considering the different needs and camera/lens you have.



#### TRIPODS

Tripod choice is more related to the general environment, stability need, transportability, max/min height, weight, specific features (such as materials, for example).

#### HEADS

According to their nature, heads can work well in specific situations considering several factors: Type of photography (macro, portrait, panorama, etc.), speed, precision, camera/lens type.

#### CAMERA USE



#### CAMERA TYPE

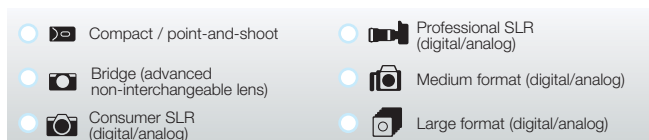

For example, macro photography needs a greater freedom of movement and a low angle; sport subjects may need a quick set up; panorama landscapes and architectural application require precision and micro adjustments. Cameras (and lenses) have different weight and are suitable for different applications. Compact and bridge cameras and consumer DSLR usually have a low weight and need therefore a lighter and more transportable support; professional DSLR are heavier and require more stability and precision. For these reasons, the right support depends on your camera equipment and the kind of photography you are looking for.

### 4) IMPROVE YOUR TRIPOD + HEAD SYSTEM: ADDITIONAL ACCESSORIES

After you have chosen your tripod+head system, you can select a wide variety of accessories and products to complete and improve your system, such as dollies, spreaders, additional feet, plates, etc.





Roma - Catania train, Sicilia, Italy.

# TRIPODS

## Tripods

The Manfrotto tripod range includes a wide variety of tripods for many different applications (from outdoor to indoor use) and different features in terms of max payload, materials, max height, compactness, considering the photographic applications and the different equipment used. The Studio range, rugged, tough and strong, specifically designed to hold heavy equipment for indoor applications; the Neotec, the fastest tripod in the world; the X family, including the well-known renewed professional 055 and 190 ranges and the new M-Y family, a range of compact and essential kits for the new DSLR users and for lightweight and compact cameras. Different tripods for different kind of photography and cameras, in order to have the perfect tool for every different need.

# STUDIO NEOTEC X M-Y

## STUDIO

Rugged, tough and strong, the Studio tripod range is ideal for studio or indoor applications and has been developed to stabilize the extra loads associated with large format cameras and lenses. Each tripod of the family has a centre column made of a “non-rollback” tube controlled by a gear mechanism. The top spider is a reinforced die casting aluminium and the legs are stabilized by an adjustable mid level spreader. The tripods offer different technologies for the locking system which can be the traditional locking knob, the quick action levers or the time tested automatic leg lock and release system used on the Triaut. With a wide range of size and weight the Manfrotto Studio family meets the needs of all the professional photographers.

## NEOTEC

This is “how a tripod should work”: how easily and quickly it should be set up and how effortlessly it should close. At the heart of this tripod lies the innovative Neotec mechanism which, hidden safely inside the leg and without any external levers or knobs, pushes outwards on the tubing to lock the leg in place at any extension.

With the patented Neotec rapid opening and closing mechanism, with no screws, knobs or levers to tighten or loosen, just pull each leg downwards to open and automatically lock it in any position. Then to fold it back up again, press the mechanism release button and push the leg closed. The mechanism exerts more locking power the heavier the weight pushing down on it from above. “Upside down” leg construction also stops the worst of the mud you’re standing in from ending up inside the tripod.

Combined with the high load capacity, great min-max height range and its full range of professional features, this makes it the ideal tripod when working under pressure.

## X

The X family is the next generation of proven-professional tripods; high-quality materials, innovative design and features, accurate control ensure that these tripods are the perfect choice for professionals and photographers who don’t want any compromise in terms of quality and performance, neither in aluminium nor in carbon fiber products.

This family includes 055 and 190 ranges, each of them available in X or CX version. X models are equipped with strong and reliable aluminium tubes; CX versions are equipped with high-quality carbon fiber tubes for maximum lightness and rigidity. 055 versions offer very high payload and greater height; 190 version features maximized lightness and compactness without compromises about performance and quality.





Furthermore, 055 and 190PRO (X or CX) versions include the patented Q90° column system, developed to move the central column from vertical to horizontal position in few seconds without disassembling the column from the tripod. A wide variety of versatile products ideal for outdoor applications. Among the models, photographers can choose the different best one for the specific application, enjoying the latest technological features coming from the Manfrotto’s creativity.





## M-Y

Designed for the first-time photographers using lightweight DSLR, and compact bridge cameras, the M-Y tripods are the perfect balanced choice for improving your photographic passion. Small, portable, compact, essential and reliable, they offer a perfect tripod+head combination. Without the hassle of choosing a separate head, M-Y tripod is always ready for mounting your camera, providing you an immediate and simple solution, ready to be taken virtually anywhere. Available in two different sizes with different payloads, M-Y tripods are equipped with three-way (suitable also for lightweight video camera application) or ball heads.

The Manfrotto's range of tripods offers a wide choice of models suitable for all the needs and different equipments, from professional cameras for outdoor and studio environments to entry-level "point and shoot" compact cameras.

The chart below summarizes the entire range of products with some highlights on the main tech specs.

TRIPODS					
	TECHNICAL SPECIFICATIONS		MATERIALS		
MODELS					
NEOTEC STUDIO	161MK2B	7.95kg	20kg		X
	058B	6.15kg	12kg		X
	475B	4.3kg	12kg		X
	028B	4.15kg	12kg		X
	458B	2.4kg	8kg		X
	055CXPRO3	1.65kg	8kg	X	
	055CXPRO4	1.70kg	8kg	X	
	055CX3	1.78kg	8kg	X	
	055XPROB	2.4kg	7kg		X
	055XB	2.3kg	7kg		X
	055XDB	2.1kg	7kg		X
	X	190CXPRO3	1.29kg	5kg	X
190CXPRO4		1.34kg	5kg	X	
190CX3		1.32kg	5kg	X	
190XPROB		1.8kg	5kg		X
190XB		1.8kg	5kg		X
190XDB		1.6kg	5kg		X
M-Y		7301YB	1.67kg	3.5kg	
	7302YB	1.47kg	3.5kg		X
	7303YB	1.34kg	3.5kg		X
	7321YB	1.27kg	2.5kg		X
	7322YB	1.02kg	2kg		X
	7323YSHB	1.09kg	2kg		X

MONOPODS					
	TECHNICAL SPECIFICATIONS		MATERIALS		
MODELS					
MONOPODS	776YB	0.33kg	4.5kg		X
	694CX	0.59kg	5kg	X	
	695CX	0.60kg	5kg	X	
	334B	0.49kg	8kg		X
	685B	0.8kg	8kg		X
	680B	0.83kg	10kg		X
	679B	0.6kg	10kg		X
	682B	1.1kg	12kg		X
	681B	0.78kg	12kg		X

Rugged, tough and strong, the Studio tripod range is ideal for studio or indoor applications and has been developed to stabilize the extra loads associated with large format cameras and lenses. Each tripod of the family has a centre column made of a "non-rollback" tube controlled by a gear mechanism.

The top spider is a reinforced die casting aluminium and the legs are stabilized by an adjustable mid level spreader. The tripods offer different technologies for the locking system which can be the traditional locking knob, the quick action levers or the time tested automatic leg lock and release system used on the Triaut. With a wide range of size and weight the Manfrotto's Studio family meet the needs of all the professional photographers.

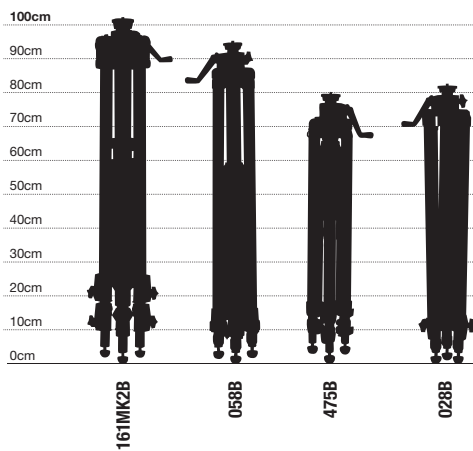

# STUDIO TRIPODS



### SUPER PRO TRIPOD 161MK2B

The tallest tripod in the range. Capable of providing a stable platform for cameras up to 20kg at a maximum height of 2.67m (on the other hand it is also capable of a minimum height of 44cm). The geared centre column is self-locking. The legs are braced using telescopic struts for maximum rigidity with individually adjustable and lockable angles. Rubber feet with retractable spiked feet and level are standard equipment. Ideal for all large format cameras. Leg section diameters in mm: 40, 35, 30.



105cm



44cm



267cm



242cm



7.95kg



20kg



114/181B

#### SUGGESTED HEADS

<b>Geared heads</b>	p. 40	400, 405
<b>Three-way heads</b>	p. 44	229, 808RC4
<b>Ball heads</b>	p. 48	468MG series, 488 series, 490, 490RC4



### TRIAUT TRIPOD 058B

The 058B Triaut has a patented system to release all three legs or any individual leg. This permits the legs to be extended, the tripod levelled (spirit level provided) and locked in seconds without 'fiddling' with individual leg adjustments. Telescoping the legs is achieved by activating the same release. Other important features of this very professional tripod are the ability to adjust all angles individually and secure them with Manfrotto telescopic struts. Favoured for medium format up to large cameras. Rubber feet with retractable spikes are standard. Includes carrying strap. Leg section diameters in mm: 30, 25, 20.



94cm



44cm



217cm



191cm



6.15kg



12kg



127/127VS/181B



The 058B features a patented simultaneous or individual leg release system that permits the legs to be extended, the tripod levelled (spirit level included) and locked in seconds without the need for individual leg adjustment.

#### SUGGESTED HEADS

<b>Geared heads</b>	p. 40	400, 405
<b>Three-way heads</b>	p. 44	229, 808RC4
<b>Ball heads</b>	p. 48	468MG series, 488 series, 490, 490RC4





### PRO GEARED TRIPOD 475B

All aluminium construction and unrivalled in stability, the 475B Pro Geared Tripod incorporates a unique centre brace structure system, reliable quick-action leg locks, non-rollback three fac ted centre column, spirit level and rubber/metal spiked feet. The revolutionary centre brace system can be operated in a symmetric or asymmetric way. This allows you to achieve two important results: fast positioning by locking the braces so that all of the legs will spread to the same angle and open instantly, or individual setting of the angle of each leg for the ultimate in tripod flexibility. To avoid annoying delays in levelling the tripod, the telescopic centre braces have been designed with two "click stop" positions that allow you to easily find the same spread angle on all three legs. The second improvement has been made to the leg locking system.

Leg section diameters in mm: 35, 30, 25.



80cm



43cm



188cm



162cm



4.3kg



12kg



114/181B

### TRIMAN TRIPOD 028B

Strong, sturdy and reliable, the Triman tripod is the ideal studio tripod. The geared centre column has a non roll-back feature and has a threaded 3/8" mount on the bottom of the column to allow low angle shots.

Twin shank leg design, built-in spirit level and rubber feet with retractable spikes are standard features.

The tripod uses a centre column strut design for added stability. Includes a mid level spreader and carrying strap. Ideal for cameras up to medium format. Leg section diameters in mm: 25, 20, 19 tandem.



82cm



77cm



227cm



179cm



4.15kg



12kg



181B

#### SUGGESTED HEADS

<b>Geared heads</b>	p. 40	400, 405
<b>Three-way heads</b>	p. 44	229, 808RC4
<b>Ball heads</b>	p. 48	468MG series, 488 series, 490, 490RC4

This is "how a tripod should work": how easily and quickly it should be set up and how effortlessly it should close. At the heart of this tripod lies the innovative Neotec mechanism which, hidden safely inside the leg and without any external levers or knobs, pushes outwards on the tubing to lock the leg in place at any extension.

With the patented Neotec rapid opening and closing mechanism, with no screws, knobs or levers to tighten or loosen, just pull each leg downwards to open and automatically lock it in any position.

Then to fold it back up again, press the mechanism release button and push the leg closed. The mechanism exerts more locking power the heavier the weight pushing down on it from above. "Upside down" leg construction also stops the worst of the mud you're standing in from ending up inside the tripod.

Combined with the high load capacity, great min-max height range and its full range of professional features, this makes it the ideal tripod for location work under pressure.

60cm  
50cm  
40cm  
30cm  
20cm  
10cm  
0cm

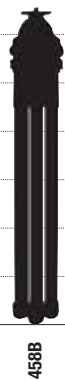

4588B



# NEOTEC TRIPOD





With its simple lines, uncluttered by protruding parts that could get caught up in clothing or camera straps, the 458B Neotec is not just a professional workhorse, practical both during transportation and in use, it's also a sleek object of design in its own right, mixing the best of Italian engineering with the best of Italian design.



Pull each leg downwards to open and automatically lock it in any position with no screws, knobs or levers to tighten or loosen.

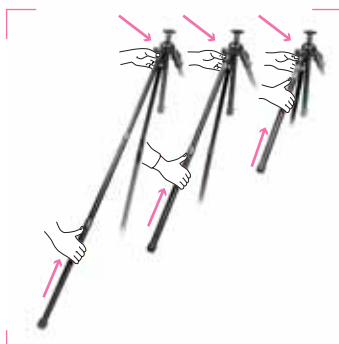

Press the mechanism release button and push the leg upwards. Release at any intermediate point to lock the leg, or push it all the way up to close.

### NEOTEC PRO PHOTO TRIPOD 458B

Awesomely fast and easy to use, the 458B has the innovative Neotec rapid opening and closing mechanism—just pull each leg downwards to open and automatically lock it in any position, with no screws, knobs or levers to tighten or loosen. Then to fold it back up again, press the mechanism release button and push the leg closed. Combined with the 458B's high load capacity, great min-max height range and its full range of professional features, this makes it the ideal tripod for location work under pressure. The 458B has a built-in carrying handle; a two-section centre column for low angle or normal shooting and four leg angle positions. "Upside down" leg construction also stops the worst of the mud you're standing in from ending up inside the tripod. Leg section diameters in mm: 28, 25, 22.

PATENTED



#### SUGGESTED HEADS

Geared heads	p. 40	405, 410
Three-way head	p. 44	808RC4
Ball heads	p. 48	468MG series, 488 series, 322RC2
Two-way heads	p. 66	128LP, 128RC, 701HDV

The X family is the next generation of proven-professional tripods; high-quality materials, innovative design and features, accurate control ensure that these tripods are the perfect choice for professionals and photographers who don't want any compromise in terms of quality and performance, neither in aluminium nor in carbon fiber products.

This family includes 055 and 190 ranges, each of them available in X or CX version.

X models are equipped with strong and reliable aluminium tubes; CX versions are equipped with high-quality carbon fiber tubes for maximum lightness and rigidity.

055 versions offer very high payload and greater height; 190 version features maximized lightness and compactness without compromises about performance and quality.

Furthermore, 055 and 190PRO (X or CX) versions include the patented Q90° column system, developed to move the central column from vertical to horizontal position in few seconds without disassembling the column from the tripod.

A wide variety of versatile products ideal for outdoor applications. Among the models, photographers can choose the different best one for the specific application, enjoying the latest technological features coming from the Manfrotto's creativity.

# X TRIPODS

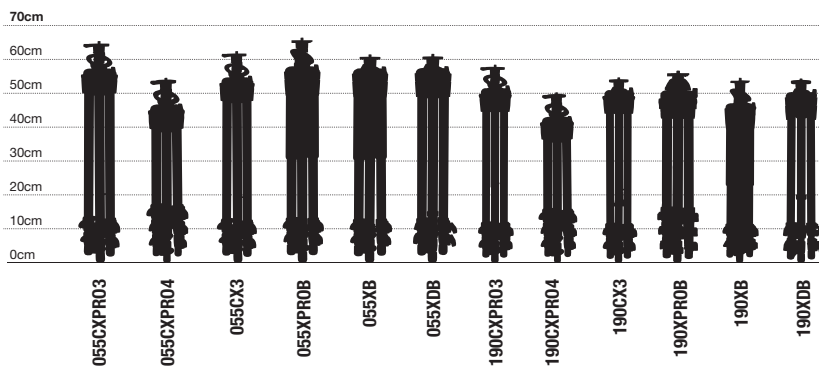



Manfrotto tubes are made of 100% carbon fiber in order to reach high quality standards and high levels of performance, rigidity and lightness. Carbon fiber tubes can be very different in quality, depending on the production process and the percent of carbon fiber material present in the tubes. Manfrotto chose to reach the maximum quality using 100% carbon fiber and the pull winding technology (a special production process able to maximize performance, resistance and reliability).



The CXPRO models include the patented Q90° system. This ingenious system allows the user to move the central column from vertical to horizontal position in just seconds without having to disassemble the column.

### 3 SECTION CARBON F./MAG. TRIPOD 055CXPRO3

The tripod specifically designed for extreme outdoor assignments. The legs and the column are made of 100% carbon fiber combined with magnesium die-casting quick action lever locking collars. Each leg can be independently set at four different angle positions. This professional tripod provides great rigidity and lightness, combined with the best professional features such as the patented Q90° centre column system. The magnesium top plate integrates a levelling bubble. Leg section diameters in mm: 29.2, 24.8, 20.4.

PATENTED



65cm



11.5cm



175cm



140cm



1.65kg



8kg



127/127VS

#### SUGGESTED HEADS

Geared heads	p. 40	405, 410
Three-way head	p. 44	808RC4
Ball heads	p. 48	468MG series, 488 series, 322RC2
Two-way heads	p. 66	128LP, 128RC, 701HDV



4 SECTION CARBON F./MAG.  
TRIPOD **055CXPRO4**

The 4 section 055CXPRO4 combines the best performances of the 055 carbon family with lower dimensions. This tripod is compact and light, with the patented Q90° system for quick vertical-horizontal movements. The legs adjustable at four different angles and an integrated levelling bubble is placed on the top plate. Leg section diameters in mm: 29.2, 24.8, 20.4, 16.

PATENTED



54.5cm



11.5cm



170cm



135.5cm



1.70kg



8kg



127/127VS

3 SECTION CARBON F./MAG.  
TRIPOD **055CX3**

This 3 section tripod combines professional performances with essential design. The 100% carbon fiber tubes provide the best rigidity and an extreme light weight. The aluminium centre column includes a low angle adapter which can be used as a short column. Leg section diameters in mm: 29.2, 24.8, 20.4.



61.5cm



6.5cm



177cm



136cm



1.78kg



8kg



127/127VS

SUGGESTED HEADS

Geared heads	p. 40	405, 410
Three-way head	p. 44	808RC4
Ball heads	p. 48	468MG series, 488 series, 322RC2
Two-way heads	p. 66	128LP, 128RC, 701HDV



Horizontal column feature allows the tripod to reach extremely low positions. Centre column can be quickly and easily swung from vertical to horizontal without any disassembly.



Built-in bubble spirit level makes camera alignment quick and easy.

## PRO TRIPOD 055XPROB

Designed for the professional photographers, this is an extremely versatile tripod, ideal for small, medium format cameras. By extending the column to its highest vertical position, it can be swung round to horizontal without removing the head or disassembling the column itself, so switching between framing and positioning setups is more convenient than ever. The ergonomics of the leg angle release mechanism and the quick action leg locks have also been greatly improved. A set of two leg warmers is included.

Leg section diameters in mm: 29.4, 25, 20.

### PATENTED



65.5cm



10cm



178.5cm



142cm



2.4kg



7kg



127/127VS

### SUGGESTED HEADS

<b>Geared heads</b>	p. 20	405, 410
<b>Three-way head</b>	p. 44	808RC4
<b>Ball heads</b>	p. 48	468MG series, 488 series, 322RC2
<b>Two-way heads</b>	p. 66	128LP, 128RC, 701HDV

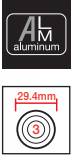

### CLASSIC TRIPOD 055XB

Built on the same ergonomically improved design as the 055XPROB but without the horizontal centre column feature, the 055XB is lighter in weight and slightly more compact. The 055XB is one of the most versatile and popular tripods in the Manfrotto range. This specific version is sturdy and portable enough to take in the field, ideal for a medium format and SLR. A low angle adapter stores on bottom of centre column. Leg section diameters in mm: 29.4, 25, 20.



### BASIC TRIPOD 055XDB

Sturdy and portable, the 055XDB is the simplest version of the 055X family, ideal for a medium format and SLR. Leg section diameters in mm: 29.4, 25, 20.



#### SUGGESTED HEADS

Geared heads	p. 40	405, 410
Three-way head	p. 44	808RC4
Ball heads	p. 48	468MG series, 488 series, 322RC2
Two-way heads	p. 66	128LP, 128RC, 701HDV





### 3 SECTION CARBON F./MAG. TRIPOD **190CXPRO3**

The 3 section 190CXPRO3 is extremely light and has great rigidity, combined with professional features such as the patented Q90° centre column system for quick vertical-horizontal movements, an integrated levelling bubble on the magnesium top plate, 100% carbon fiber tubes (including the centre column) and magnesium die castings. Leg section diameters in mm: 24.8, 20.4, 16.

PATENTED



58cm



8cm



146cm



122cm



1.29kg



5kg



127/127VS

#### SUGGESTED HEADS

Geared heads	p. 40	410
Three-way head	p. 44	056, 460MG, 804RC2
Ball heads	p. 48	222, 484, 484RC2, 486, 486RC2
Two-way heads	p. 66	128LP, 128RC, 391RC2, 700RC2



#### 4 SECTION CARBON F./MAG. TRIPOD **190CXPRO4**

The 4 section 190CXPRO4 combines great compactness and improved rigidity with maximum height. It's extremely light and includes professional features such as the patented Q90° centre column system for quick vertical-horizontal movements, an integrated levelling bubble on the magnesium top plate, 100% carbon fiber tubes (including the centre column) and magnesium die castings.

Leg section diameters in mm: 24.8, 20.4, 16, 11.6.

##### PATENTED



50cm



8cm



146cm



122cm



1.34kg



5kg



127/127VS

#### SUGGESTED HEADS

Geared head	p. 40	410
Three-way heads	p. 44	056, 460MG, 804RC2
Ball heads	p. 48	222, 484, 484RC2, 486, 486RC2
Two-way heads	p. 66	128LP, 128RC, 391RC2, 700RC2



### 3 SECTION CARBON F. TRIPOD **190CX3**

The 3 section 190CX3 combines great performance with essential and functional design. 100% carbon fiber tubes and aluminium die castings guarantee great rigidity and extremely light weight. The aluminium centre column includes a low angle adapter at the bottom which can be used as a short column. Leg section diameters in mm: 24.8, 20.4, 16.



55cm



6cm



146cm



119cm



1.32kg



5kg



127/127VS

#### SUGGESTED HEADS

<b>Geared head</b>	p. 40	410
<b>Three-way heads</b>	p. 44	056, 460MG, 804RC2
<b>Ball heads</b>	p. 48	222, 484, 484RC2, 486, 486RC2
<b>Two-way heads</b>	p. 66	128LP, 128RC, 391RC2, 700RC2



### PRO TRIPOD 190XPROB

Newly redesigned, the 190XPROB makes the famous Manfrotto-patented horizontal centre column feature even easier to use. Now, by extending the column to its highest vertical position, it can be swung round to horizontal without removing the head or disassembling the column itself, so switching between framing and positioning setups is more convenient than ever. The ergonomics of the leg angle release mechanism and the quick action leg locks themselves have also been greatly improved.

Leg section diameters in mm: 25, 20, 16.

**PATENTED**



### ALU TRIPOD 190XB

Built on the same ergonomically improved design as the 190XPROB but without the horizontal centre column feature, the 190XB is lighter in weight and slightly more compact.

Leg section diameters in mm: 25, 20, 16.



#### SUGGESTED HEADS

Geared heads	p. 40	410
Three-way head	p. 44	056, 460MG, 804RC2
Ball heads	p. 48	222, 484, 484RC2, 486, 486RC2
Two-way heads	p. 66	128LP, 128RC, 391RC2, 700RC2



### ALU TRIPOD 190XDB

Lightweight, sturdy and portable, this renewed tripod is the easiest of all Manfrotto 190X family tripods to handle. This tripod has been designed for small and medium format. Equipped with a two-way head can also be an ideal support for spotting scopes or camcorders or digital video camcorders. Leg section diameters in mm: 25, 20, 16.



53.5cm



35cm



146cm



118.5cm



1.6kg



5kg



127/127VS

#### SUGGESTED HEADS

Geared heads	p. 40	410
Three-way head	p. 44	056, 460MG, 804RC2
Ball heads	p. 48	222, 484, 484RC2, 486, 486RC2
Two-way heads	p. 66	128LP, 128RC, 391RC2, 700RC2

Designed for the first-time photographers using lightweight DSLR, and compact bridge cameras, the M-Y tripods are the perfect balanced choice for improving your photographic passion. Small, portable, compact, essential and reliable, they offer a perfect tripod+head combination. Without the hassle of

choosing a separate head, M-Y tripod is always ready for mounting your camera, providing you an immediate and simple solution, ready to be taken virtually anywhere. Available in two different sizes with different payloads, M-Y tripods are equipped with three-way (suitable also for lightweight video camera application) or ball heads.

# M-Y TRIPODS

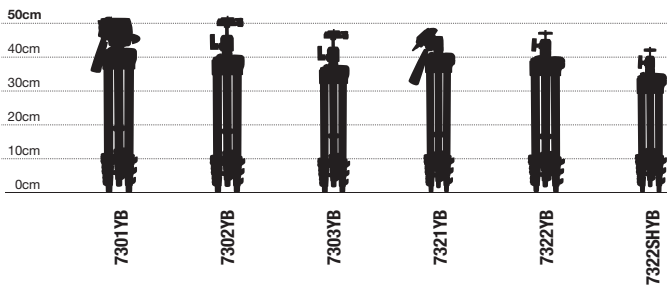



Rotating selectors for changing the leg angle.



Ergonomic levers with anti-slip rubber.



New design for the top spider. Aluminium die casting.

### M-Y TRIPOD WITH 3-WAY HEAD 7301YB

The 7301YB has an integrated 3-way aluminium head. This tripod is designed for providing smooth movements when using small video cameras or photographic equipment. The head has separate pan and tilt locks, a quick release plate and a short ergonomic bar, particularly useful for panning or tracking moving subjects. The tripod legs can be set independently in two different angle positions thanks to a new designed selection system. The product comes complete with a carrying bag.

Leg section diameters in mm: 26, 22, 18, 14.



51cm



36cm



143cm



126cm



1.67kg



3.5kg



200PL



M-Y TRIPOD WITH BALL HEAD **7302YB**

The 7302YB incorporates a quick release ball head with +90°/-90° orientation grooves and repositionable locking lever. Legs can be set at two different angles. It comes complete with a carrying bag. Leg section diameters in mm: 26, 22, 18, 14.



51cm



36cm



144cm



126cm



1.47kg



3.5kg



200PL





### M-Y TRIPOD WITH BALL HEAD **7303YB**

A four sections tripod embedding a compact ball head. Legs adjustable at two different angles. Complete with carrying bag.  
Leg section diameters in mm: 26, 22, 18, 14.



48.5cm



34.5cm



142cm



124cm



1.34kg



3.5kg



200PL



M-Y TRIPOD WITH 3-WAY HEAD **7321YB**

The 7321YB is a tripod-head system with an improved lightness and compactness. The tripod has a built-in video/photo 3-way head with ergonomic bar, independent pan and tilt locks, quick release plate. The legs are adjustable at two different angles. It comes with a carrying bag.  
 Leg section diameters in mm: 22, 18, 14, 10.5.



49cm



35cm



142cm



123cm



1.27kg



2.5kg



785PL



**M-Y TRIPOD WITH BALL HEAD 7322YB**

A four section compact tripod with a small ball head. Legs adjustable at two different angles. Complete with carrying bag.  
Leg section diameters in mm: 22, 18, 14, 10.5.

48cm	34cm	141cm	122cm	1.09kg	2kg

**M-Y TRIPOD WITH BALL HEAD 7322SHYB**

The most compact tripod belonging to the M-Y family. It provides an extremely reduced size without any compromise of stability and performance. The 7322SHYB is a four section tripod with two different angle positions for the legs. The system includes a compact ball head. It can be easily transported thanks to the short folded length. Complete with carrying bag.  
Leg section diameters in mm: 22, 18, 14, 10.5.

42cm	31.5cm	119cm	100cm	1.02kg	2kg



Haines Highway, Alaska

# HEADS

## Heads

As well as the tripod, it's fundamental to choose a proper and balanced head considering your camera equipment, the photo application and the tripod you are going to use. Manfrotto range includes a wide group of different kind of heads for different payloads and applications: geared heads, a Manfrotto invention designed primarily for studio use and offering micro-precise framing, ultra-safe support with great load capacity;







three-way heads, characterized by the fact that the movement on each axis is separately controlled by individual locks for more secure support; ball heads, the fastest heads to adjust thanks to their single lock/unlock mechanism which releases the ball and socket joint to rotate on all axes (available also in the hydrostatic version, able to have an incredible lock with a simple move); joystick heads, a patented Manfrotto's

invention, with a unique, fast and ergonomic release system; two-way heads, a crossover from the video sector, popular with users of long heavy lenses and sport optics; VR panoramic heads, used to create single-row cylindrical or multi-row spherical composite photographic images for immersive virtual environments or simply for panorama prints.

TWO-WAY  
**GEARED**  
JOYSTICK  
THREE-WAY  
BEARHEADS  
TWO-WAY  
JOYSTICK  
VR  
THREE-WAY  
TWO-WAY  
JOYSTICK  
HEADBALLED



Choose the right head for your camera and your need. The choice of the right head is important in order to match the characteristics of your tripod and exploit all the possibilities of your camera. Manfrotto offers you the right product depending on the specific application. The following chart introduces you all the Manfrotto's heads with their characteristics:

HEADS							
	TECHNICAL SPECIFICATIONS		MATERIALS			QUICK RELEASE PLATE	
MODELS							
<b>GEARED</b>	400	2.6kg	10kg		X	400PL-LOW / 400PL-MED / 400PL-HIG	
	405	1.6kg	7.5kg		X	410PL	
	410	1.22kg	5kg		X	410PL	
<b>3-WAY</b>	804RC2	0.79kg	4kg			X	200PL
	808RC4	1.42kg	8kg		X		410PL
	460MG	0.43kg	3kg	X			200PL-14
	056	0.5kg	3kg		X		
	391RC2	0.7kg	5kg		X		200PL-14
	229	1.9kg	12kg		X		030-14
<b>BALL</b>	468MGRC2	0.65kg	10kg	X			200PL-14
	468MG	0.65kg	16kg	X			
	468MGRC0	0.84kg	16kg	X			030-14
	468MGRC3	0.8kg	16kg	X			357PLV
	468MGRC4	0.73kg	16kg	X			410PL
	468MGRC5	0.74kg	12kg	X			501PL
	490	1.05kg	12kg		X		
	490RC4	1.12kg	12kg		X		410PL
	488	0.56kg	8kg		X		
	488RC2	0.67kg	8kg		X		200PL-14
	488RC4	0.8kg	8kg		X		410PL
	488RC0	0.83kg	8kg		X		030-14
	486	0.38kg	6kg		X		
	486RC2	0.46kg	6kg		X		200PL-14
	484RC2	0.32kg	4kg		X		200PL-14
484	0.25kg	4kg		X			
482	0.09kg	2kg		X			
<b>JOYSTICK</b>	322RC2	0.7kg	5kg		X		200PL-14
	222	0.78kg	2.5kg		X		200PL-14
<b>VR</b>	303SPH	2kg	4kg		X		357PLV
	303PLUS	2.2kg	5kg		X		
	303	1.65kg	5kg		X		
	300N	0.52kg	14kg		X		
<b>2-WAY</b>	128LP	1kg	4kg		X		
	128RC	1kg	4kg		X		200PL-14
	700RC2	0.52kg	2.5kg		X		200PL-14
	701HDV	0.83kg	4kg		X		501PL

Manfrotto was the first company in its field to introduce the three-way geared head mechanism. These heads provide the best level of precision for professional applications.

The result is a range of different models, each one designed to support small, medium and large formats cameras. All the models offer incredible stability and precision. Photographers can choose the best model depending on the load capacity required.



# GEARED HEADS





### GEARED HEAD 400

This unique head offers precise geared movement in 3 directions. Fold away rotating handles for pan and tilt; and side to side levelling by a separated handle. In addition, the tension holding the round quick release plate can be released to allow fine adjustment with complete safety. Designed to mount on either studio column stands or larger tripods, this geared head for medium and large format cameras, provides the ultimate in fine adjustment and control to achieve the exact framing required. Three 1/4" screws for camera attachment included.



16cm



2.6kg



10kg



400PL-LOW  
400PL-MED  
400PL-HIG



Pan 360°



Frontal Tilt  
-90° +30°



Lateral Tilt  
-7.5° +7.5°



### PRO GEARED HEAD 405

Speed and digital precision are stunning in the latest 405 Pro Geared Head. It provides ideal support and fast, pinpoint positioning for professional medium format cameras. The 405 Pro Geared Head was designed specifically to meet the more exacting, time-sensitive needs of busy professional digital photographers who shoot with medium format or 35mm camera/back with payloads up to 7.5kg. It utilizes large, easy-to-grip knobs that provide smooth, positive, geared control through 360° pan and +90° -30° frontal and lateral tilt. In addition to its 3-D geared functions, the 405 also incorporates a unique feature that allows you to instantly disengage the gears and roughly position the camera by hand, then instantly reengage them for ultra-precise final alignment. Camera attachment: 1/4" + 3/8" screw.

**PATENTED**

-   
16cm
-   
1.6kg
-   
7.5kg
-   
410PL
-   
Pan 360°
-   
Frontal Tilt  
-30° +90°
-   
Lateral Tilt  
-90° +30°



### JUNIOR GEARED HEAD 410

Extremely compact, this unique head offers gear movement in three directions, pan, tilt and side to side tilt. The head incorporates a quick release camera plate system and is suitable for 35mm SLR and medium format cameras.  
 Camera attachment: 1/4" + 3/8" screw.

**PATENTED**



13cm



1.22kg



5kg



410PL



Pan 360°



Frontal Tilt  
-30° +90°



Lateral Tilt  
-90° +30°

The Manfrotto's three-way heads are the best solution for quickly controlling the camera maintaining a good precision, engineered to provide smooth and independent control of pan, back and forward tilt plus side to side tilt movements. In fact, the camera position can rapidly change from landscape (horizontal) to portrait (vertical) or adjusted to the appropriate angle that best suits the shot.

Large rubber grips on the pan and tilt handles provide efficient control and the range includes models with quick release camera plate systems which enable cameras to be interchangeable quickly or to go from tripod to hand held and back rapidly.



# THREE-WAY HEADS



### BASIC PAN TILT HEAD WITH QUICK RELEASE PLATE **804RC2**

3-way photo head constructed of ultra-durable and lightweight technical polymer, the 804RC2 easily withstands the daily rigors of the professional photographer. A unique spring feature has been added to the 804RC2 to assist in the tilt motion of the head to compensate for heavier, off-centre loads. Ergonomic and newly designed handles fit comfortably in the hands, while the standard quick release plate fits snugly in the low-profile receiver. Optional plates: 200PL-38, 200PLARCH-14, 200PLARCH-38.



12cm



0.79kg



4kg



200PL



Pan 360°

Frontal Tilt  
-30° +90°Lateral Tilt  
-90° +30°

### STANDARD 3-WAY HEAD WITH QUICK RELEASE PLATE **808RC4**

The 808RC4 streamlines our range of 3-way heads by incorporating new elements while maintaining all the features you loved. There are two balance springs in the vertical tilt (forward/backward) and horizontal tilt (left/right) movements. These springs enable you to more comfortably handle heavier camera loads (such as very long lenses) with minimal effort. Both springs can be turned off in case normal head operation is required. The head is comprised of aluminium and designed in a manner to support up to 8kg yet lightweight and small enough to pack in any camera kit. The standard quick release system is used to accommodate larger camera platforms and incorporates dual axis bubble levels to achieve level shots.



15.6cm



1.42kg



8kg



410PL



Pan 360°

Frontal Tilt  
-30° +90°Lateral Tilt  
-90° +30°

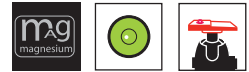

### 3D MAGNESIUM HEAD 460MG

An innovative 3D head. Cast from lightweight magnesium, the head can be positioned in virtually any position to get the exact framing of the 0 image. The lock-system using spring-loaded conical joints allows greater flexibility than any other 3D head whether mounted on a tripod centre column or lateral arm. The rubber grip knobs provide finger tip control. The 460MG is the ideal head in combination with the 35mm SLR and medium format cameras. Camera attachment: 1/4".  
Optional plates: 200PL-38, 200PLARCH-14, 200PLARCH-38.

-   
10.5cm
-   
0.43kg
-   
3kg
-   
200PL-14
-   
Pan 360°
-   
Frontal Tilt  
-30°+90°
-   
Lateral Tilt  
-180°+30°



### 3D JUNIOR HEAD 056

A self-adjusting conical bearing locking system allows 360° rotation on both the vertical and horizontal plane. This is the ideal head for 35mm and light to medium format work. Camera attachment: 1/4" screw.  
Optional plates: 323, 394.

-   
10cm
-   
0.5kg
-   
3kg
-   
Pan 360°
-   
Frontal Tilt  
-30°+180°
-   
Lateral Tilt  
-180°+30°



### JUNIOR HEAD 391RC2

The new 3-way aluminium head designed to allow both still photography and video application. It is equipped with a quick release plate system and Teflon pads to ensure smooth pan and tilt movements with independent locks. The bar is padded with soft not-slip rubber.



9.5cm



0.57kg



5kg



200PL-14



Pan 360°



Frontal Tilt  
-90°+90°



Lateral Tilt  
-0°+90°



### 3D PRO HEAD 229

Finely machined for greater positioning with smooth, certain action. Three built-in spirit levels for horizontal and vertical control. The head has a quick release camera plate with secondary safety catch for added security. Camera attachment: 1/4" + 3/8" screw. Optional plates: 030-38, 030ARCH-14, 030ARCH-38, 030HAS, 030L, 130-14, 130-38.



16cm



1.9kg



12kg



030-14



Pan 360°



Lateral Tilt  
-25° +90°



Frontal Tilt  
-90° +30°

Manfrotto Ball Heads are the right choice to reduce dimensions and quickly move your camera, and are the right solution for quickly shooting using small and medium format cameras. A wide family of heads with different dimensions and payloads, for every need and equipment to support.

The camera is unblocked and blocked by using a single knob. Many models allow to control the movement of the camera by tuning the friction forces on the ball.

# BALL HEADS





The Hydrostatic most is the advanced ball head family from Manfrotto.

Designed to meet the demand of professional photographers for a lightweight, but at the same time heavy duty load capacity ball head, these heads feature a revolutionary friction and locking mechanism.

The oversized lock knob hides a patented locking mechanism which uses the fundamental criteria of the hydraulic laws, locking the camera in such a secure position it gives the impression it has become one solid part of the head.

Designed for camera and lens loads of up to 16kilos, the hydrostatic heads have a magnesium die cast body, a 2" Teflon coated aluminium ball providing movement as smooth as silk. A calibrated adjustable tension control allows you to preset the ball tension to suit your camera weight and give you fingertip control. The range includes six different versions featuring a variety of quick release plate fixings.



HYDROSTATIC BALL HEAD WITH RC2 RAPID CONNECT SYSTEM **468MGRC2**

The 468MGRC2 has a quick release 200PL top plate.

-   
12cm
-   
0.65kg
-   
10kg
-   
200PL-14
-   
Pan 360°
-   
Tilt +90°-90°



**HYDROSTATIC BALL HEAD 468MG**

Basic version of the Manfrotto's hydrostatic heads. Camera plate with a 1/4" male thread.

-   
13cm
-   
0.65kg
-   
16kg
-   
Pan 360°
-   
Tilt +90°-90°



**HYDROSTATIC BALL HEAD WITH RC0 RAPID CONNECT SYSTEM 468MGRC0**

Hydrostatic head equipped with a quick release 030 camera plate system. With a secondary safety lock and two spirit levels.

-   
13.5cm
-   
0.84kg
-   
16kg
-   
030-14
-   
Pan 360°
-   
Tilt +90°-90°



**HYDROSTATIC BALL HEAD WITH RC3 RAPID CONNECT SYSTEM 468MGRC3**

Version equipped with a 357PLV sliding plate system.

-   
12cm
-   
0.8kg
-   
16kg
-   
357PLV
-   
Pan 360°
-   
Tilt +90°-90°



HYDROSTATIC BALL HEAD WITH RC4 RAPID CONNECT SYSTEM **468MGRC4**

Equipped with a quick release 410PL camera plate. With a secondary safety lock and two spirit levels.

-   
12cm
-   
0.73kg
-   
16kg
-   
410PL
-   
Pan 360°
-   
Tilt +90°-90°



HYDROSTATIC BALL HEAD WITH RC5 RAPID CONNECT SYSTEM **468MGRC5**

Version equipped with a 501PL sliding plate system.

-   
12cm
-   
0.74kg
-   
12kg
-   
501PL
-   
Pan 360°
-   
Tilt +90°-90°

The standard ball heads represent the right choice for those who are looking for a basic and simple head. They are a good solution to quickly move and block the camera in a very simple way.

The Manfrotto's standard ball heads family provides different solutions for different needs, with a wide payload range (from 12kg to 2kg). The models designed for high loads are equipped with an additional friction control system for moving the camera with the right resistance.



### MAXI BALL HEAD 490

The top of Manfrotto's range of centre ball heads in die-cast aluminium with precision phenol resin ball. The 490's features make it versatile and ideal for digital and traditional photographic equipment from 35mm to 20x25cm format up to 12kg in weight. It features separate locks on 360° pan and +90° -90° tilt movements, with an additional friction control on the ball movement to give just the right resistance and smoothness with minimum effort, even with varying weight of equipment on board. The Maxi Ball Head attaches to the camera via a 50mm platform with an ingeniously combined 1/4" and 3/8" male thread. Head to tripod attachment is 3/8" female.



14cm



1.05kg



12kg



Pan 360°



Tilt +90°-90°



### MAXI BALL HEAD WITH RC4 RAPID CONNECT SYSTEM 490RC4

Same as the 490 but equipped with a quick release 410PL camera plate system with a secondary safety catch and two spirit levels for precise levelling on both vertical or horizontal axes. Camera plate has 1/4" male thread. Head to tripod attachment is 3/8" female.



13.7cm



1.12kg



12kg



410PL



Pan 360°



Tilt +90°-90°



### MIDI BALL HEAD 488

With its solid aluminium construction and phenolic resin ball, this head is the ideal support for all traditional or digital small or medium format cameras. It features separate fast action "ratchet" locks on 360° pan and +90° -90° tilt movements. You can position your camera anywhere in 180° sphere with confidence and ease. Camera attachment is via a 50mm platform with 1/4" male thread. Head to tripod attachment is 3/8" female.



11.2cm



0.56kg



8kg



Pan 360°



Tilt +90°-90°



### MIDI BALL HEAD WITH RC2 RAPID CONNECT SYSTEM 488RC2

Same as the 488 but equipped with a quick release 200PL camera plate system with a secondary safety catch. Camera plate has 1/4" male thread. Head to tripod attachment is 3/8" female.

Optional plates: 200PL-38, 200PLARCH-14, 200PLARCH-38.



10.8cm



0.67kg



8kg



200PL-14



Pan 360°



Tilt +90°-90°



### MIDI BALL HEAD WITH RC4 RAPID CONNECT SYSTEM 488RC4

Same as the 488 but equipped with a quick release 410PL camera plate system with a secondary safety catch and two spirit levels for precise levelling on both vertical or horizontal axes. Camera plate has 1/4" male thread. Head to tripod attachment is 3/8" female.



11.5cm



0.8kg



8kg



410PL



Pan 360°



Tilt +90°-90°



**MIDI BALL HEAD WITH RCO RAPID CONNECT SYSTEM 488RC0**

Same as the 488 but equipped with a quick release 030 camera plate system with a secondary safety catch and two spirit levels for precise levelling on both vertical or horizontal axes. Camera attachment has 1/4" male thread. Head to tripod attachment is 3/8" female. Optional plates: 030ARCH-14, 030ARCH-38, 030HAS, 130-14, 130-38, 030L.

-   
13.4cm
-   
0.83kg
-   
8kg
-   
030-14
-   
Pan 360°
-   
Tilt +90°-90°



**COMPACT BALL HEAD 486**

The Compact Ball Head is strong enough to take 35mm SLR cameras with medium lenses, and light medium format cameras. It has a single indexed "ratchet" locking knob for 360° pan and +90° -90° tilt movements. Camera attachment is via a 50mm platform with 1/4" male thread. Head to tripod attachment is 3/8" female. All aluminium construction and black finish.

-   
9.2cm
-   
0.38kg
-   
6kg
-   
Pan 360°
-   
Tilt +90°-90°



**COMPACT BALL HEAD WITH RC2 RAPID CONNECT SYSTEM 486RC2**

Same as the 486 but equipped with a quick release 200PL camera plate system with a secondary safety catch. Camera plate has 1/4" male thread. Head to tripod attachment is 3/8" female. Optional plates: 200PL-38, 200PLARCH-14, 200PLARCH-38.

-   
10cm
-   
0.46kg
-   
6kg
-   
200PL-14
-   
Pan 360°
-   
Tilt +90°-90°



### MINI BALL HEAD WITH RC2 RAPID CONNECT SYSTEM **484RC2**

This versatile head is fitted with a quick release 200PL camera plate system with a secondary safety catch. The head is perfect for 35mm SLR cameras with medium lenses, and light medium format cameras. Head to tripod attachment is 3/8" female. Optional plates: 200PL-38, 200PLARCH-14, 200PLARCH-38.



9.5cm



0.32kg



4kg



200PL-14



Pan 360°



Tilt +90°-90°



### MINI BALL HEAD **484**

Designed for use with compact, 35mm and small digital cameras. The strong die-cast construction, precision-machined aluminium housing and extremely hard phenolic resin ball provide excellent smooth movements across all tilt positions. A single "ratchet" control lever securely locks both the +90°-90° ball and the 360° pan movements. Camera attachment is via a 50mm platform with 1/4" male thread. Head to tripod attachment is 3/8" female.



7.5cm



0.25kg



4kg



Pan 360°



Tilt +90°-90°



### MICRO BALL HEAD **482**

All-purpose ball head designed for compact, 35mm and small digital cameras. This head is ideal for the Table Top Tripod 209, Car Window Clamp 243 and monopods such as the 776YB. It has a single indexed "ratchet" locking knob for 360 pan° and +90° -90° tilt movements. Camera attachment is via a 50mm platform with 1/4" male thread. Head to tripod attachment is 1/4" and 3/8" female. All aluminium construction and black finish.



5.8cm



0.09kg



2kg



Pan 360°



Tilt +90°-90°

The patented Manfrotto's joystick heads are an iconic invention with peculiar and unique features, offering a unique ergonomic solution for quickly unblock, move and block again your camera.

The joystick heads allow the user to freely frequently reposition the camera although it's still mounted on the tripod. The Manfrotto's design and the shutter release remote controls make the use of these heads extremely simple, ergonomic and intuitive.







### HORIZONTAL GRIP ACTION BALL HEAD **322RC2**

Take the versatility of a ball head, add true ergonomic control and you get the 322RC2: a photographic head that allows you to unblock, move, position and lock your camera with one hand in one position thanks to the revolutionary design of its grip handle, which incorporates the ball lock lever and can also mount the 322RS shutter release accessory. A friction control wheel lets you regulate the power of the blocking mechanism to match the weight of your camera/lens. The 322RC2 is made from magnesium for lightweight performance, and is designed to keep the weight of your kit as close as possible to the tripod's centre of gravity by way of its reduced height. It is this fact, matched with the precision construction of the 322RC2 that gives the head its load capacity of 5kg. Complete with built-in bubble spirit level and quick release camera plate (standard 1/4" screw, with secondary safety pin). Suitable for use with 35mm or medium format cameras.

Optional plates: 200PL-38, 200PLARCH-14, 200PLARCH-38.  
PAT. PENDING

-   
10.3m
-   
0.7kg
-   
5kg
-   
200PL-14
-   
Pan 360°
-   
Frontal Tilt  
-90°+90°
-   
Lateral Tilt  
-3°+90°

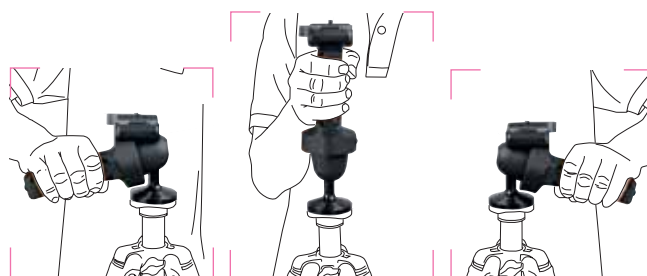

**ERGONOMICS**  
Whether you're left handed or right, whether you prefer a horizontal grip or vertical, the 322RC2 is practical and ergonomic. Customise the location of the camera plate to suit your ideal working position.

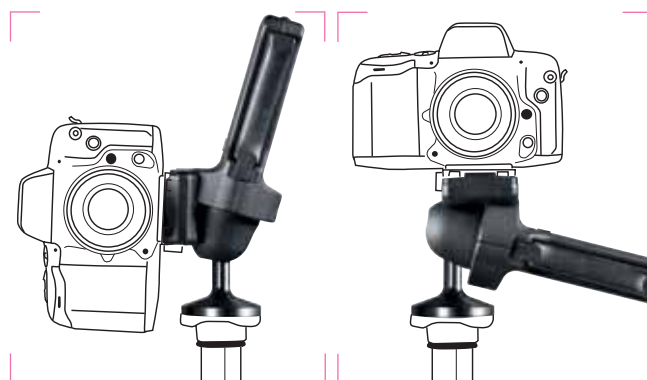

**CENTRE OF GRAVITY**  
In turn, aligning the camera close to the tripod centre of gravity gives the 322RC2 an extraordinary 5kg load capacity. Lateral tilt movement: -3°/+90°.



BACK VIEW  
Double action switch 2.5mm stereo jack.

**ELECTRONIC SHUTTER  
RELEASE KIT 322RS**

The remote control electronic shutter release kit fits the 322RC2 Grip Action Ball Head and puts control of your camera's shutter down on the head itself, so you can take photos the moment you're in position, without having to move your hand from the head grip up to the camera body. The 322RS can be fitted to the head no matter which position you choose to use it in, for both right and left handed photographers. PAT. PENDING



**CABLE SHUTTER  
RELEASE KIT 322RSM**

The cable shutter release kit fits the 322RC2 Grip Action Ball Head and puts control of your camera's shutter down on the head itself, so you can take photos the moment you're in position, without having to move your hand from the head grip up to the camera body. The 322RS can be fitted to the head no matter which position you choose to use it in, for both right and left handed photographers.

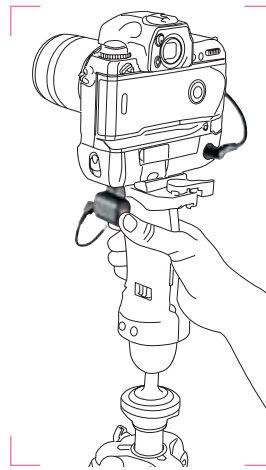

322RS fitted for right-handed use of the 322RC2 head in vertical position.

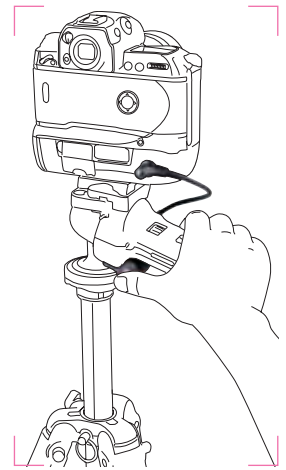

322RS fitted for right-handed use of the 322RC2 head in horizontal position.

For checking the compatibility between Manfrotto's camera shutters please visit [www.manfrotto.com/322RSM.html](http://www.manfrotto.com/322RSM.html)

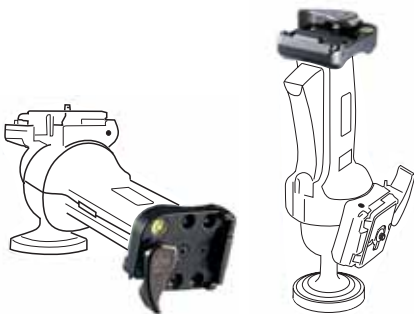

**ADDITIONAL CAMERA PLATE ADAPTER FOR 322RC2 322RA**

Camera plate adapter assembly for the 322RC2 can also be available as a separate accessory in case you want the camera to be as close as possible to the tripod's centre of gravity, which provides a higher rate of stability.



**BLACK GRIP ACTION BALL HEAD 222**

Versatile, quick and easy to use. Just grip the handle and you can position your camera anywhere within a 180° sphere. Supplied with quick release camera plate with secondary safety lock, built-in bubble level and tension adjustment. Made of cast aluminium. Ideal for 35mm cameras with short or medium focal length lenses. Camera attachment: 1/4". Optional plates: 200PL-38, 200PLARCH-14, 200PLARCH-38.

**PATENTED**



21cm



0.78kg



2.5kg



200PL-14



Pan 360°



Tilt +90°-90°

A wide range of heads useful for different panoramic photo applications, from traditional flat or cylindrical panoramas to complete 360° x 360° cubic and spherical views. Cubic and spherical panoramas allow the shooting of the complete environment around you and provide a way to

virtually immerse your audience into your vision. Natural spaces and architectural projects can be accurately and interactively visualized. The Manfrotto VR heads have been designed to be the perfect tool for all these kind of Virtual Reality applications.



Object panorama

Use the 300N base as a turntable to spin a 3D object through sequential constant angle movements in front of your camera until a 360° cycle has been completed. Superimpose the images in the correct order using your chosen software to allow viewers to see the object from all angles.



Spherical panorama

Use the 303, 303PLUS or 303SPH head plus a 185° fisheye lens. Take two photos at 180° to each other, then stitch them together to create a 360°x360° spherical panorama.



Cylindric panorama

Use the 303, 303PLUS or 303SPH head to spin your camera around its nodal point through a longitudinal sequence of constant angle shots on the same level which can be stitched together (basically... placed edge to edge) using your chosen software to create a single row "cylindrical" panorama.



Multi-row / cubic panorama

Use the 303SPH to spin your camera around its nodal point through both latitudinal and longitudinal sequences of constant angle shots which can then be stitched together and composite to create a multi-row cubic 360°x360° panorama.

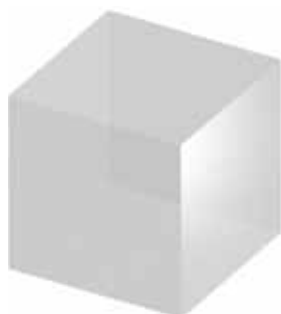

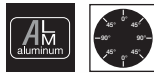

APPLICATION  
Multi-Row cubic panorama

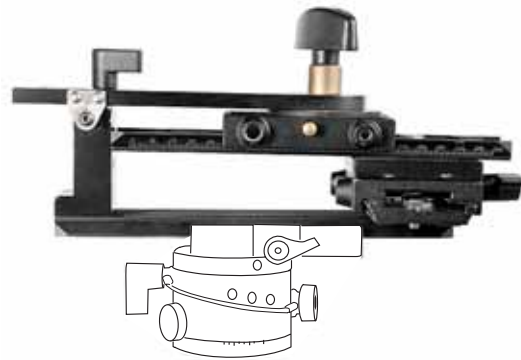

### MULTI ROW PAN HEAD 303SPH

The 303SPH is a multi-row panoramic photography head. It has sliding plates to locate the camera over the panoramic axis of rotation, plus a sliding plate which rotates around the front/back tilt axis. This allows the camera to be rotated on both horizontal and vertical axes around the camera/lens nodal point, so multi-row panoramic photo sequences (cubic VR photos) can be taken accurately and easily. Using the 303SPH ensures that software used for photo stitching produces a precisely composed VR environment with minimum post-production intervention or software correction. All plates and rotation index guides on the 303SPH have clear markings to allow easy repositioning of the camera once nodal point position has been identified and noted down. The 303SPH's vertical bracket can be unlocked and rotated through 90° (then re-locked) so that the head takes up less space in transport, and so that the sliding plate mechanisms are protected against knocks and bumps. The 303SPH comes complete with an extra set of sliding plates for use with cameras of different sizes.



32cm



2kg



4kg



357PLV

### UPGRADE KIT: CONVERTS 302 INTO 303SPHUK HEAD 303SPHUK

The 303SPHUK upgrade kit is essentially a 303SPH head without the 300N Pan Rotation Unit or the plate attachment that locks onto the 300N; by using these components from the old model 302 head, photographers can use their existing pan head as a basis to build a 303SPH-like product. Remember however that the 300N rotation unit has been improved compared to that supplied with the original 302 family.

#### 303SPH FEATURES

- Three sliding plates for precise nodal point positioning on all planes/axes.
- Short plates included for more convenient use with compact cameras.
- Long plates included for use with larger SLR or medium format cameras.
- Camera attachment via 1/4" and 3/8" male screw.
- 3/8" female tripod fitting.
- Graduated scale from 0° to 360° on lower part of 300N rotation unit.
- Dual graduated scale to set the angle of rotation to any of the following: 90°, 60°, 45°, 36°, 30°, 24°, 20°, 15°, 10°, 5° (respectively equivalent to 4, 6, 8, 10, 12, 15, 18, 24, 36 or 72 photos to achieve a full 360° rotation) on upper part of 300N rotation unit.
- By removing vertical brackets, the 303SPH can also be used as an object turntable.
- Vertical bracket folds down and removes for compact size during transport.



**APPLICATION**  
Precision cylindrical panorama



### PRECISION PAN HEAD 303PLUS

The 303PLUS advanced panoramic photography head is built around the 300N pan rotation unit, with sliding plates for nodal point positioning and an elbow bracket to allow the camera to be mounted in either portrait or landscape orientation. It incorporates precise geared movements of the two sliding plates used to locate the camera over the panoramic axis of rotation, adding greater accuracy to nodal point positioning. The micro-positioning plates provide extremely precise fingertip adjustment via a gear drive system; a release button disengages the gear drive to facilitate rapid movement of the plates when required. The plates are also longer than those of the 303 head, which helps to make this head suitable for use with larger traditional or digital SLR cameras equipped with standard or wide angle lenses, or for medium format cameras.



31.3cm



2.2kg



5kg

#### 303PLUS FEATURES

- Double micro positioning sliding plates - 180mm long with 120mm of adjustment for precise nodal point positioning.
- Convenient quick release elbow bracket with 1/4" and 3/8" male screw for camera attachment.
- Dual graduated scale to set the angle of rotation to any of the following: 90°, 60°, 45°, 36°, 30°, 24°, 20°, 15°, 10°, 5° (respectively equivalent to 4, 6, 8, 10, 12, 15, 18, 24, 36 or 72 photos to achieve a full 360° rotation) on upper part of 300N rotation unit.
- 3/8" female tripod fitting.
- Graduated scale from 0° to 360° on lower part of 300N rotation unit.
- By removing vertical brackets, the 303PLUS can also be used as an object turntable.



APPLICATION  
Cylindric panorama



### PAN HEAD 303

The 303 pan head permits the photographer to take sequential constant-angle shots around a single axis with his or her camera either in portrait or landscape position, and with the nodal point of the camera/lens in line with the centre of panoramic rotation to ensure that parallax effects do not cause problems during image stitching. It is built around (and includes) the 300N panoramic unit, adding a system of sliding horizontal and vertical plates for accurate positioning of the camera nodal point. The plates have engraved index rules to make subsequent repositioning easier. The included quick release elbow bracket lets the photographer use the portrait orientation of the camera gaining vertical field. The system is suitable for most 35mm SLR still and digital stills cameras using wide-angle or standard lenses.



31.3cm



1.65kg



5kg

#### 303 FEATURES

- Double sliding plate with 80mm of adjustment for precise nodal point positioning.
- Convenient quick release elbow bracket with 1/4" and 3/8" male screw for camera attachment.
- 3/8" female tripod fitting.
- Dual graduated scale to set the angle of rotation to any of the following: 90°, 60°, 45°, 36°, 30°, 24°, 20°, 15°, 10°, 5° (respectively equivalent to 4, 6, 8, 10, 12, 15, 18, 24, 36 or 72 photos to achieve a full 360° rotation) on upper part of 300N rotation unit.
- Graduated scale from 0° to 360° on lower part of 300N rotation unit.
- By removing vertical brackets, the 303 can also be used as an object turntable.





APPLICATION  
Cylindric panorama



APPLICATION  
Object panorama base



## PAN ROTATION UNIT **300N**

The 300N panoramic rotation unit allows the photographer to take sequential constant-angle shots around a single axis, an essential part of achieving accurate and easy-to-stitch panoramic compositions. The set positions of the 300N give ample choice of rotation angle and so of number of photos needed to complete a 360° pan and cover the most common requests of panoramic photographers depending on the camera/lens equipment used.

To make angle selection easier, a “click-stop” selector screw is included and attached to a safety cable to prevent it from being separated from the head and getting lost. The 300N also comes complete with a secondary locking screw which stops unwanted or accidental rotation of the head when heavy or off-centre equipment makes it less balanced or when the head is used for non-horizontal rotation.

The 300N can also be used as a turntable base for object panoramas, or as a means of reading the angle of rotation of camera pan movements in a range of photography. A camera can be mounted on the panoramic unit by adding one of a range of quick release, sliding or fixed plates or a conventional geared, ball or 3-way head.



6.3cm



0.52kg



14kg

### 300N FEATURES

- Upper dual graduated scale to set the angle of rotation to any of the following: 90°, 60°, 45°, 36°, 30°, 24°, 20°, 15°, 10°, 5° (respectively equivalent to 4, 6, 8, 10, 12, 15, 18, 24, 36 or 72 photos to achieve a full 360° rotation based on 35mm film frames or 24x36mm CCD).
- Lower graduated scale from 0° to 360°.
- 3/8" female tripod fitting; 3/8" male screw head or plate fitting.

The two-way heads family is a broad sweep of heads designed for a offering smooth and fluid movement. It's possible to choose among the available models with different payloads and counterbalance power.

These heads can be employed for hybrid photo/video/birdwatching applications, supporting video cameras, still cameras with medium/long tele lenses, scopes or binoculars.



# TWO-WAY HEADS



### PRO FLUID VIDEO MINI HEAD **701HDV**

Developed specifically to support the latest prosumer and professional light compact HD camcorders, the 701HDV offers an updated design, which has been created for improved ergonomics with locks and knobs that allow for a more solid grip and better control, a better fluidity thanks to improved internal fluid cartridges, a double pan-bar rosette and a bigger sliding plate to optimize the position of the camera considering its centre of gravity.



9.5cm



0.83kg



4kg



501PL



Pan 360°



Tilt -60°+90°



### MINI VIDEO HEAD BLACK **700RC2**

A compact and lightweight 2-movement video head designed principally to support the latest digital video equipment but also suited to still photography cameras with medium and long tele lenses. The 700RC2 has a fixed length pan bar with soft handle and separate locking mechanisms for the 360° pan and the +90°/-75° tilt. Smooth and constant movements on both axes are assured by a fixed system of fluid cartridges.

Equipped with quick release 200PL-14 video plate system with VHS PIN and a secondary safety catch. Head to tripod attachment is 3/8" female. Optional plate: 200PL-38.



9.6cm



0.52kg



2.5kg



200PL-14



Pan 360°



Tilt -75°+90°



### MICRO VIDEO HEAD 128LP

The micro video head is perfect for lightweight video cameras, and includes an adjustable pan bar. It has smooth fluid movement, pan and tilt locks. The adjustable pan bar can be positioned either on the left or right side. Optional plate adapters: 323, 394, 577.

-  11cm
-  1kg
-  4kg
-  Pan 360°
-  Tilt -90°+90°

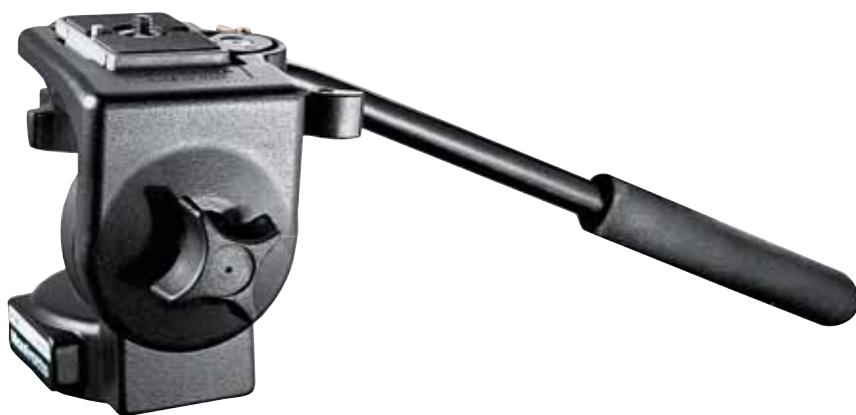

### MICRO VIDEO HEAD BLACK 128RC

A lightweight fluid head with adjustable pan bar and quick release camera plate with secondary security, ideal for cameras up to 4kg in weight. It has smooth fluid movement, pan and tilt locks. Optional plate: 200PL-38.

-  11.5cm
-  1kg
-  4kg
-  200PL-14
-  Pan 360°
-  Tilt -60°+90°



Ischia, Campania, Italy.

# MONOPODS

## Monopods

Besides the tripod, the monopod is the best way to hold a camera in situations where space is limited, the quantity and weight of the equipment carried on location needs to be kept to a minimum, or set-up speed is needed.

Correctly handled, the monopod supplies all the camera support you are likely to need even for long lenses. Because monopods are an important part of every photographer's support equipment, Manfrotto's monopod range

includes many different models, considering different materials (carbon fiber or aluminium), number of sections, payload, locking technology, max height, compactness.



# MONOPODS





### AUTOMATIC MONOPOD 334B

The automatic, 3 section, monopod provides immediate single handed final height adjustment. Squeeze the trigger handle and the top section can be raised or lowered, release and it locks in position. The lower two sections have a twist lock action for additional height adjustment. The top plate has a dual 1/4"-3/8" camera fixing screw.

Section diameters in mm: 22, 25, 28.

**PATENTED**

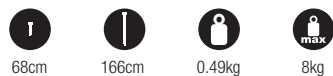

### NEOTEC PRO PHOTO MONOPOD 685B

The fastest monopod in the world! The 685B features the innovative Neotec rapid opening and closing mechanism – just pull the leg downwards to open and it automatically locks in any position, with no screws, knobs, or levers to tighten or loosen. Then to fold it back up again simply release the safety latch and pull the trigger and push the leg closed. A convenient rubber pedal attached to the bottom section allows you to open the monopod without having use your other hand. It's 'upside-down' leg construction also prevents water or mud from entering the monopod and a padded leg-warmer protects your hands from hot and cold weather.

Section diameters in mm: 22, 25, 28.

**PATENTED**



### COMPACT MONOPOD 680B

Four section monopod featuring sure rubber grip, wrist carrying strap, quick action lever leg lock system with 45° run, large 60mm camera/head platform with plastic cover and dual 1/4" - 3/8" camera fixing screw.

Section diameters in mm: 35.4, 29.5, 25, 20.

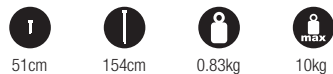

### PROFESSIONAL MONOPOD 681B

Robust three section monopod featuring sure rubber grip, wrist carrying strap, quick action lever leg lock system with 45° run, large 60mm camera/head platform with plastic cover and dual 1/4" - 3/8" camera fixing screw.

Section diameters in mm: 35.4, 29.4, 25.





**MONOPOD 679B**

Three section monopod featuring sure rubber grip, wrist carrying strap, quick action lever leg lock system with 45° run, large 60mm camera/head platform with plastic cover and dual 1/4" - 3/8" camera fixing screw. Section diameters in mm: 29.4, 25, 20.



64cm



162cm



0.6kg



10kg



**SELF-STANDING PRO MONOPOD 682B**

All the features of the professional monopod 681B with a handy addition of three retractable legs. Dual 1/4" - 3/8" coaxial camera fixing screw. Section diameters in mm: 35.4, 29.4, 25.

**PATENTED**



74cm



172cm



1.1kg



12kg



**5 SECTION CARBON FIBER MONOPOD 695CX**

Five section, light weight carbon fiber and magnesium collars monopod. Extremely compact with a minimum length of transportation. The four leg extensions allow the monopod to be rapidly extended to its maximum height. The monopod is equipped with a rapid action extension locks, a wrist strap and a camera platform with dual 1/4" and 3/8" camera fixing screw. Section diameters in mm: 29.2, 24.8, 20.4, 16, 11.6.



47.5cm



160.5cm



0,60kg



5kg



**4 SECTION CARBON FIBER MONOPOD 694CX**

Four section, lightweight carbon fiber and magnesium locking collars monopod. The best solution for sporting events, it allows photographers to shoot over the heads of everyone. The monopod has a rapid action extension locks, a wrist strap and a camera platform with dual 1/4" and 3/8" camera fixing screw. Section diameters in mm: 29.2, 24.8, 20.4, 16.



54cm



165cm



0.59kg



5kg



**M-Y MONOPOD 776YB**

Nothing is more compact, light and quick than a M-Y monopod. When you don't need the total "hands free" support of a tripod, a monopod is the best solution. Four sections, lightweight monopod with rapid action extension locks for compact spotting scopes. 1/4"-20" fixing screw. Section diameters in mm: 26, 22, 18, 14.

**PATENTED**



48cm



152.5cm



0.330kg



4.5kg



**MONOPOD TILT TOP 234**

Simple tilt head to allow a camera on a monopod to be turned 90° to provide either vertical or horizontal format.



6cm



0.27kg



2.5kg



**MONOPOD QUICK RELEASE TILT TOP 234RC2**

As 234 but with quick release camera plate system and secondary safety lock.



6cm



0.27kg



2.5kg



200PL-14

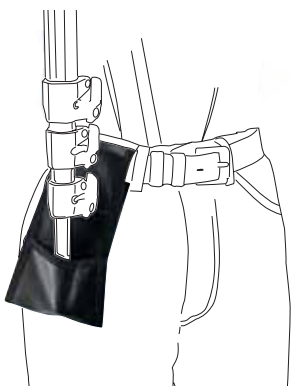

**MONOPOD BELT POUCH 080**

Worn on a belt, this easy to use pouch offers support for the base of a monopod.



**SPIKED FOOT FOR MONOPOD 236**

Converts 679B, 680B and 681B series monopods rubber foot to a spiked foot.



**RUBBER SPIKE FOOT - STAINLESS STEEL 676SP2 · 695SP2 · 449SP2**

Reversible rubber/metal spiked foot supplied with a dedicated fixing tool. The spike is made of a special hard anodised aluminium alloy extremely resistant to corrosion.  
 676SP2: for monopods 679B and 680B.  
 695SP2: for monopod 695CX.  
 449SP2: for monopods 776YB and 694CX.



**SUCTION CUP/RETRACTABLE SPIKE FOOT 676SC2 · 695SC2 · 449SC2**

A rubber suction cup foot with retractable stainless steel spike. The suction cup increases the suitable area of the foot of the monopod by almost 20 times, giving much greater stability when needed. The foot can be removed and replaced at will.  
 676SC2: for monopods 679B and 680B.  
 695SC2: for monopod 695CX.  
 449SC2: for monopod 694CX.



**RUBBER/SPIKED FOOT 677SPN**

Rubber foot for with retractable metal spike, for monopod 681B.



**SUCTION CUP/RETRACTABLE SPIKE FOOT 677SCN**

A rubber suction cup foot with retractable stainless steel spike. The suction cup increases the suitable area of the foot of the monopod by almost 20 times, giving much greater stability when needed. The foot can be removed and replaced at will. For monopod 681B.

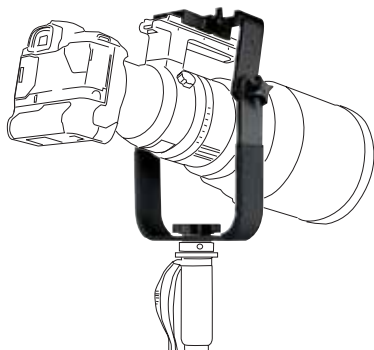

**LONG LENS MONOPOD BRACKET 393**

Specifically developed for use with very long lenses on monopods. Key features: Friction base which enables the bracket to pan on monopod, also can be used on a tripod. Two rubber hand grips plus rubber protection to prevent damage to lens when tilted to maximum. Variable centre height adjustment in three steps.



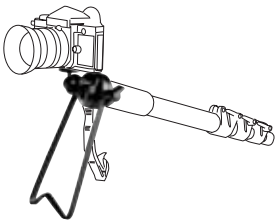

### MONOPOD SUPPORT **331**

Fixed on the monopod, adds two points of support making it stable on any surface regardless of the inclination. Allows long exposures on automatic release. Comes complete with the Mini Ball Head 482. Attachment - 3/8" female for monopod.

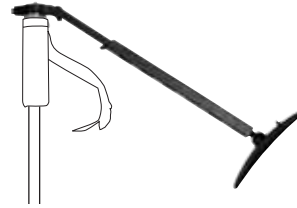

### SHOULDER BRACE FOR MONOPOD **361**

Designed to fit to the top end of any make of monopod to give additional stability. Adjustable length with pivoting shoulder support.



### UNIVERSAL FOLDING BASE **678**

This unique accessory allows you to add a base made of three foldable high strength steel legs to the monopods 679B, 680B, 681B. After using them the legs can be folded and stored inside the bottom section of the monopod ready in a few seconds when needed.



0.42cm



14kg



Terre di Siena, Toscana, Italy

# DOLLIES

Dollies

Manfrotto dollies and spreaders maintain a tripod at a secure spread.

Dollies provide instant manoeuvrability around the studio or on location and all have fast action foot controlled braking systems.

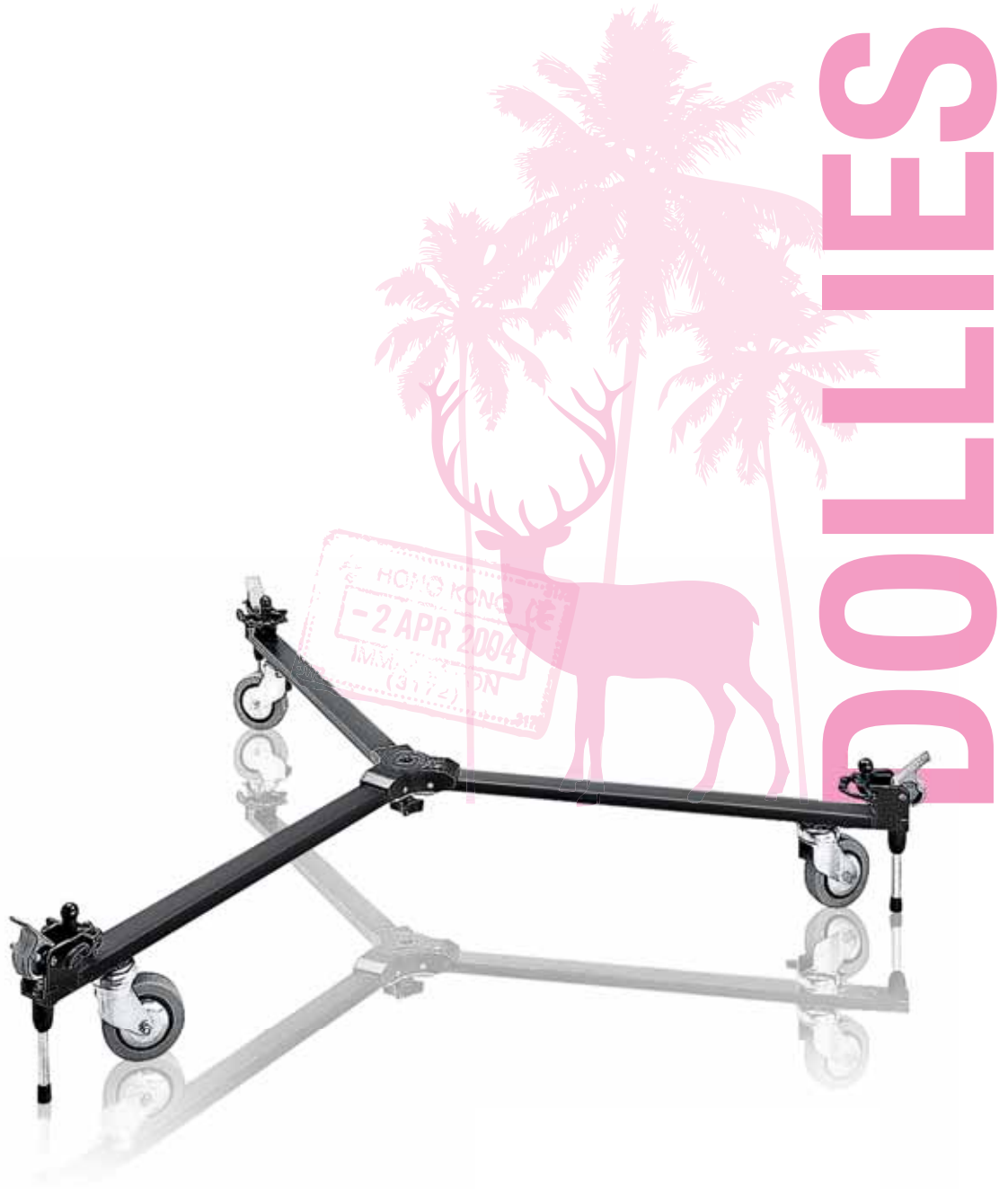





**VIDEO DOLLY 114**

Heavy duty, super sturdy dollies are designed for large still and video tripods. They feature large 127mm individually braked wheels with cable guards. Folds for transporting.

Designed for Manfrotto's tripods: 161MK2B, 058B, 475B.



8kg



112cm



**BASIC DOLLY 127**

Designed for light and medium weight tripods. The 76mm wheels have a sure-lock feature that raises the wheels free of the ground so that the dolly rests on separate feet.

Designed for Manfrotto's tripods: 055CX3, 055CXPRO3, 055CXPRO4, 055XPROB, 055XB, 055XDB, 190CX3, 190CXPRO3, 190CXPRO4, 190XPROB, 190XB, 190XDB, 458B.



2.4kg



110cm



**PORTABLE DOLLY 127VS**

Everything that the 127 has with the addition of variable spread to the legs. Suitable for standard and spiked feet.

Designed for Manfrotto's tripods: 055CX3, 055CXPRO3, 055CXPRO4, 055XPROB, 055XB, 055XDB, 190CX3, 190CXPRO3, 190CXPRO4, 190XPROB, 190XB, 190XDB, 458B.



3.4kg



78 to 114cm



**TRIPOD SPREADER 165**

Universal tripod spreader with variable diameter width controls from 80cm to 130cm.

Designed to work with most Manfrotto tripods.



0.65kg



80 to 130cm



**FOLDING AUTO DOLLY 181B**

Single lever braking system controls all three 80mm wheels. Includes 3/8" attachment which allows you to fix a head for low angle shooting. It folds legs for transporting and storage.

Designed for Manfrotto's tripods: 161MK2B, 058B, 028B, 475B.



4.5kg



127cm



Jaipur, Rajasthan, India.

# ALTERNATIVE SUPPORTS

## Alternative supports

Manfrotto is proud to be the only brand in the market to offer a wide and complete support system for your imaging passion.

Besides tripods and heads, alternative supports such as magic arms, super clamps, hydrostatic

arms, nano clamps, suction cups, etc., are fundamental parts of every professional photographer's tool box, giving the ability to adapt your supporting equipment considering the different environments and the specific application.

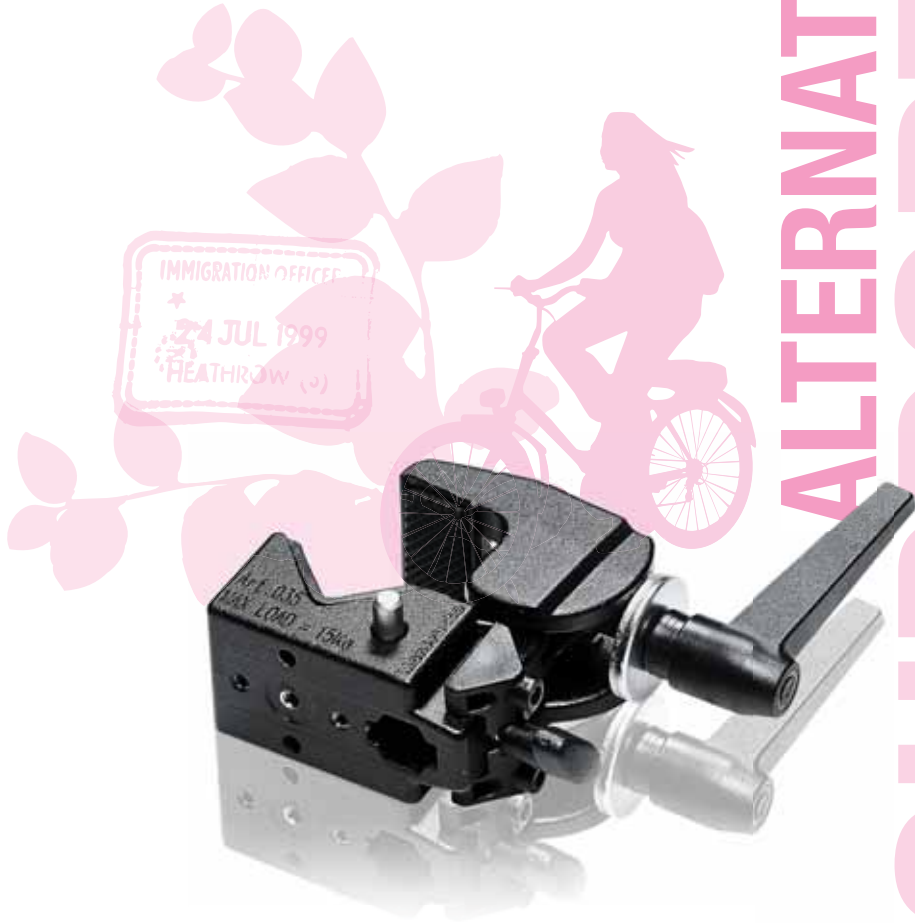

# ALTERNATIVE SUPPORTS



**VARIABLE FRICTION ARM WITH QUICK RELEASE PLATE 244RC**

Articulated arm with large locking knob. Variable friction and locking of arm obtained by adjusting the knob. Supplied with quick release camera plate with secondary safety lock based on the 200PL-14 camera plate mechanism. Ideal for mounting a photographic or video camera exactly at the angle you need it. Fits any 5/8" female socket, works especially well with Super Clamp 035C.



1.11kg



4kg



200PL-14



**MAGIC ARM WITH QUICK RELEASE PLATE 143RC**

Your extra arm in the studio. One lever locks three pivot points. Supplied with a quick release camera plate with secondary safety lock based on the 200PL-14 system. Ideal for mounting a camera or a camcorder exactly at the angle you need it. Fits any 5/8" female sockets, works especially well with Super Clamp 035C.



1.09kg



4kg



200PL-14



**MEDIUM HYDROSTATIC ARM 823**

This is the first arm that features 5/8" and 1/4" pins to support larger and heavier items. One of the two pins is hex shaped to marry perfectly with our Super Clamp. With a total length of 23.5cm, the 823 is ideal to position lighting fixtures or cameras virtually anywhere. To ensure that all three feet make contact with the ground on any terrain.



4kg



0.55kg



**SMALL HYDROSTATIC ARM 819**

This arm spans 18cm and can support up to 2.2kg. The 819 is the ideal companion for attaching a video monitor to a camera or using as a flag support. The pivoting pins are 1/4" and 3/8" threaded with one adjustable platform ring offering a larger footprint for the equipment being supported by the arm.



2.2kg



0.215kg



**MINI HYDROSTATIC ARM 814**

A small and incredibly powerful arm (max load is 3.5kg.) that spans 13cm. The pivoting pins are 1/4" and 3/8" threaded with one adjustable platform ring offering a larger footprint for the equipment being supported by the arm.



3.5kg



0.21kg



**SUPER CLAMP 035C**

This universal clamp can be securely mounted on any tube from 13 to 45mm. Attachment is 5/8" hexagonal socket. Equipped with ratchet handle.



0.25kg

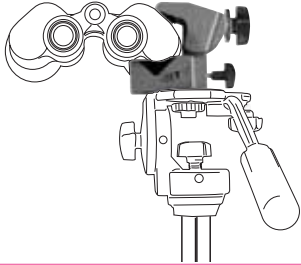

**BINOCULAR SUPER CLAMP 035BN**

Designed to securely hold binoculars.



0.25kg



**NANO CLAMP 386BC**

Its the new Manfrotto small size clamp. Its reduced size is the most important plus: the Nano Clamp is 4kg of payload in 110 grams of weight and the right size for any pocket.

The Nano Clamp is also a full pack of new technological advances:

- a new patented unexposed thread system
- a new high friction tape which improves the grip
- high performance aluminium
- pull and lock aluminium handle
- unique surface design that was studied on the smallest surface to able to grip round or flat tube/pole surface.

The clamp comes with a 1/4"-3/8" adapter.



4kg



0.11kg

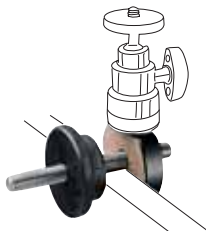

**PHOTO CLAMP 296**

Can be fixed to surfaces up to 60mm thick. Has 2x3/8" male threads for mounting ball head and camera.



**COLUMN CLAMP 349**

Versatile clamp designed to work in conjunction with removable tripod columns of between 25 to 28mm diameter such as the 055 and 190 series tripods. The Column Clamp can be securely fixed to solid surfaces or bars up to 55mm width. The column with head is inserted into the clamp and locked in position at the required height. The ideal accessory for nature photography or support for binoculars and scopes.



**DOUBLE BALL TILT HEAD 155RC**

Not strictly a tripod head, but an extremely versatile camera support for compact and 35mm cameras used in conjunction with Super Clamp 035C. Supplied with quick release camera plate and secondary safety lock.



15cm



0.6kg



5kg



200PL-14

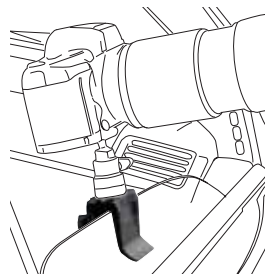

**CAR WINDOW POD 243**

Used for attaching either 482 or 234 heads to a window or narrow sill. Attachment screw is 3/8". Ball head not provided.



### DIGI TABLE TRIPOD 709B

A tiny table-top tripod perfect for a number of applications. Fits in your pocket or in its own belt-loop carrying pouch (available as an accessory) and sets up in seconds to provide a stable shooting platform that can be used virtually anywhere, indoors or out. The 709B comes complete with an integrated Manfrotto Mini Ball Head providing 360° pan and  $\pm 90^\circ$  tilt. Black finish.



20cm



11cm



11cm



0.2kg



2kg



### SILVER BRIGHT DIGI TABLE TRIPOD 709BR

Same design, size and features as the 709B but in a stylish bright silver finish.



### TABLE TOP TRIPOD KIT 345

Small and portable, this table top tripod kit fits into any camera bag ready to give quick support to a lightweight camera. Compromises: Mini Ball Head 482, Table Top Tripod 209, Extension 259B (extension from 15.6cm to 25cm) and Bag 345BAG (also sold as individual items).



19cm



25cm



35.5cm



0.3kg



2kg

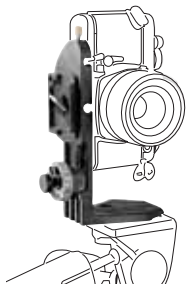

**JUNIOR ELBOW BRACKET 341**

The Junior Elbow Bracket enables you to rapidly change from a horizontal to a vertical shooting axis, without having to reposition the tripod. Its adjustable stop prevents accidental camera rotation. Great for small & medium sized cameras equipped with telephoto lenses. Its new design allows you to use this handy accessory on all heads equipped with the 200PL type of camera plate.



0.32kg

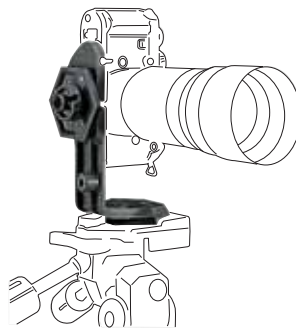

**ELBOW BRACKET 340**

The Elbow Bracket enables one to rapidly change from a horizontal to a vertical shooting position, without having to reposition the tripod and to keep an axis of vision which is vertical to the tripod itself, thus avoiding the threat of tilting. Compatible with the following heads: 029, 229 and 488RC0. Comes complete with 1/4" to 3/8" screws.



0.32kg

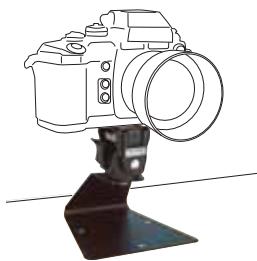

**TABLE SUPPORT 355**

This simple table mounting support is supplied with three holes for fixing or clamping. Comes complete with the Monopod Tilt Head 234.

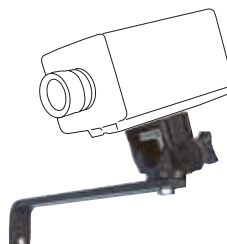

**WALL SUPPORT 356**

As for the 355 but designed to be mounted to a wall. Comes complete with the Monopod Tilt Head 234.

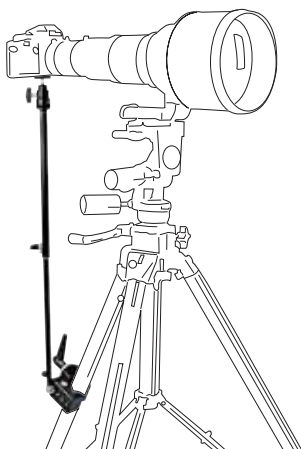

**LONG LENS CAMERA SUPPORT 359**

A very useful addition to any photographers complement of attachments. Complete with Super Clamp 035C and Mini Ball Head 482. Fully adjustable between 40cm and 60cm with a simple telescopic locking device.



0.69kg

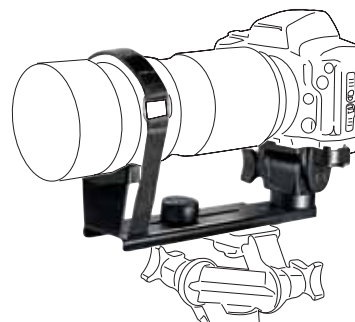

**TELEPHOTO LENS SUPPORT 293**

As for the 355 but designed to be mounted to a wall. Comes complete with the Monopod Tilt Head 234.





**AIR CUSHIONED TABLE CENTRE POST 385**

In view of the increasing demand for shop display systems for still & video cameras, we have produced a centre column equipped with a standard 58mm disc and three grub screws as used on our 190 and 055 tripods. This also means the column can be combined with any head from our range. The bottom of the column has an 80mm disc which can be screwed directly to countertop/table or, alternatively, bolted to the included second disc on the underside of the countertop. Specifications: Column diameter: 30mm / 26mm - Minimum height 36cm - Maximum height 62cm - Weight 1.1kg load capacity 10kg. Available only in black finish.

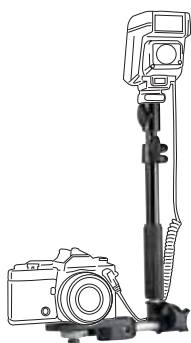

**CAMERA BRACKET 233B**

Camera flash bracket with telescopic column from 30cm to 45cm.



1kg

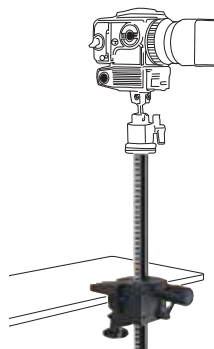

**TABLE CENTRE POST 131TC**

Geared column with clamp for table thickness from 18-38mm, for supporting a camera adjustable between 5cm and 66cm. Head not included.



**MONITOR/PROJECTOR HOLDER 183**

Made of sturdy aluminium, this 25x35cm platform can support up to 20kg. It is ideal as a projector or monitor stand.



1kg



20cm

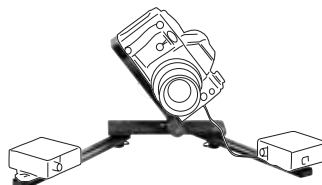

**MACRO BRACKET FLASH SUPPORT 330B**

Allows two flash heads to be mounted with a camera onto a tripod head. Attachments: 3/8" & 1/4" female threads & 1/4" camera fixing screw.



0.35kg



1kg



### CAMERA SUCTION MOUNT **241V**

Attaches to most non-porous surfaces.  
Ideal camera support in automobile or next to a window.



1.5kg



3kg



### PUMP CUP WITH FLAT BASE **241FB**

Suction Cap for lightweight photographic and video equipment, such as 35mm. SLR, digital cameras and lightweight video cameras. The 60mm diameter disc with a 3/8" W male thread is built in the pump cup and enables you to mount most of Manfrotto's heads.



0.62kg



### PUMP CUP **241**

Suction cup for small fixtures and lightweight equipment.  
Diameter: 150mm.



1.2kg



### MICRO POSITIONING PLATE **454**

Ideal for macro photography to make precise positioning movements to achieve the perfect framed shot, for QTVR and other precise copy/repro work, the new sliding plate has finger-tip control for hairsbreadth positioning but with a simple lock-release lever for fast set-up. Two plates can be interlocked at 90° for full lateral/ forward/ /back movement (over 120mm). In extruded aluminium, the plate has 1/4" and 3/8" holes and screws for tripod and camera mounting.  
Dimension: 180x57,5x15mm.



0.45kg



8kg



### TOOL KIT **WMANTOOL**

Set of tools (2) to adjust the locking collars of most of Manfrotto's tripods, stands and monopods.  
The kit comprises a PHILLIPS screwdriver TYPE 2 and a hexagonal tubular SOCKET N. 8.



**CAMERA MOUNTING STUD 037**

Reversible stud with 3/8" and 1/4" designed for mounting cameras flush on Super Clamp 035C.



**SMALL ADAPTOR 088LBP**

Converts 1/4" screw to 3/8".



**JOINT FOR ARMS 120DF**

Adapter 3/8" F-1/4" F allows using accessory arms 131DB and 131DDB as column extensions.  
Diameter: 60mm.



**FLASH SHOE 143S**

Flash shoe.

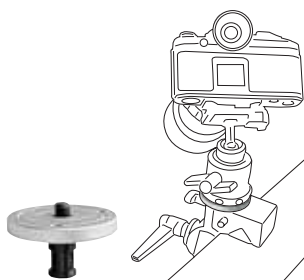

**CAMERA MOUNTING ADAPTOR 208**

Allows use of 3/8" camera mounting plate in to 16mm socket. Compatible with Super Clamp 035C and 484RC2 or 486RC2 Ball Head for example.  
Diameter: 59.5mm.



**CAMERA MOUNTING ADAPTOR HEXAGONAL PIN 208HEX**

Its main feature is the hexagonal pin, which, compared to the 208's round one, gives more grip when used to hold heavy cameras mounted on photo or video heads in combination with accessories like the Super Clamp 035C.



**NIKON FLASH ADAPTOR 262**

Converts Nikon flash mount to universal flash bracket.



**METZ FLASH SCREW 248**

A special long 1/4" camera screw used in conjunction with the hexagonal 030 camera plate which allows you to fit the Metz flash bracket.



**SURVEY ADAPTOR 273**

Converts tripod head screw from 3/8" threads to 5/8".



**SURVEY PLATE ADAPTOR ACCESSORY PLATE 358**

Spare plate code for 324.



**SURVEY PLATE ADAPTOR 324**

This adaptor is made of two pieces: a 5/8" bushing with a 3/8" female attachment to connect it to a tripod and a removable plate 124mm diameter with a 5/8" male thread that should stay connected to the equipment. With the 324 it is possible to transform any Manfrotto tripod into a tripod compatible with the standard attachment interface system used in the survey and measuring industry.



**ANTI THEFT PLATE 030AT**

For heads with hexagonal plates. Key lock system for camera release and 200cm steel cable.



0.45kg



**ACCESSORY LONG PLATE 430**

Allows two camera mounting positions. Supplied with 2x1/4" and 2x3/8" camera fixing screws.  
Dimension: 280x80x10mm.



**LEG WARMERS 380**

Set of 3 Manfrotto Patented Leg Warmers, which have a zip system so they can be easily fitted and will not slip down in use. Offer good grip. Protect the legs and insulate your hands when using the tripod in cold weather.  
For tripods series 055. Length 355mm.

**LEG WARMERS 381**

For tripods series 190. Length 250mm.



### LOOK OUT STAND **269HDB-3U**

The special attachment allows you to fix on top of the stand either a camera head, or directly a camera. Using a triple levelling leg system and a levelling bubble, the position of your camera can be adjusted in order to shoot wherever and however it is needed.



730cm

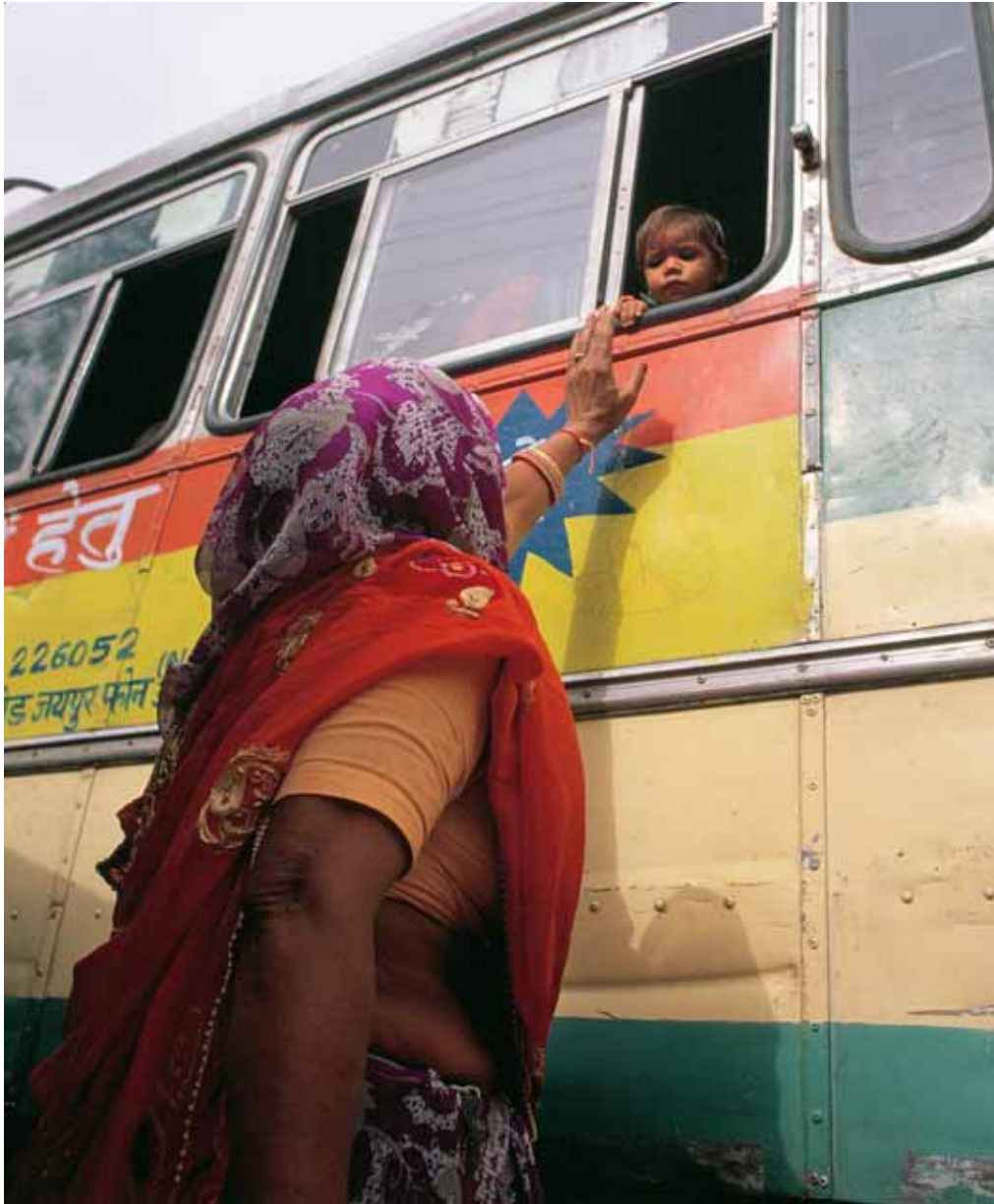

Mandawa, Rajasthan, India.

# ACCESSORIES

Accessories

Head plates, tripod feet, monopods accessories, adapters, leg warmers, and more: a incredible wide variety of accessories to complete your equipment and having a customized support system for your camera.



# ACCESSORIES





**BASIC PANORAMIC HEAD ADAPTER 627**

Basic panoramic adapter that can be mounted on top of a head, monopod, or tripod. The adapter camera platform has a graduated scale in millimeters to set the camera position during different shooting sequences and a dual 1/4" and 3/8" camera fixing screw. This accessory can be connected to a head, monopod, or tripod by a 3/8" female attachment.



**BALL CAMERA LEVELER 438**

The 438 is fitted between tripod and head and provides easy, fast levelling for tripods without built-in levelling mechanisms. Its range of movement is 10°.

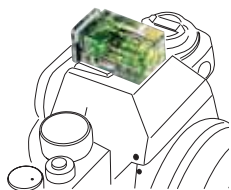
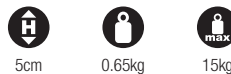

**HOT SHOE TWO AXIS BUBBLE LEVEL 337**

The 337 is a double axis spirit level that mounts to the hot shoe of any standard 35mm SLR camera to help you achieve a finer degree of accuracy and consistency in panoramic photo sequences.



**LEVELLING BASE 338**

The 338 is fitted between tripod and head and is used in combination with tripods that don't have built-in levelling mechanisms. Its three adjustment dials enable the operator to make fine, finger tip adjustments up to +/- 5 degrees to ensure the camera is perfectly level. The dials also have locking rings to ensure stability once the right position is reached.

A spirit level is built in for reference. The base has a 3/8" female tripod fitting and a 3/8" male head fitting.



**SHORT COLUMN 055CCSB**  
**SHORT COLUMN 190CCSB**

To improve the positioning flexibility of our tripods, a shorter centre column is now available as an accessory which can be ordered separately. If you need to work with legs set at the third angle of inclination (about 60°) but still require the possibility to move the camera up and down to achieve perfect adjustment for the shot, this shorter column replaces the one supplied with the tripod.

The lengths are:

17.5cm for the 055CCSB - 16.5cm for the 190CCSB.

055CCSB for tripods series 055 - 190CCSB for tripods series 190.



LOW ANGLE ADAPTER FOR 190 RANGE **190LAA**  
 LOW ANGLE ADAPTER FOR 055 RANGE **055LAA**

Low angle adapter to store at the bottom of the centre column when the tripod legs angle is set to 43°, 73° and 90°.



LEVELLING CENTRE COLUMN **555B**  
 LEVELLING CENTRE COLUMN **556B**

Our innovative system means you can quickly level your photo or video head without needing to make time-consuming adjustments to the length and angle of each single tripod leg. One of the most common problems in still photography and, above all, video has been resolved by Manfrotto, thanks to the use of a 50mm diameter levelling half ball mounted at the top of a tripod centre column so as to make the angle of the top plate independent of the rest of the tripod. Locking and unlocking of the half ball is via a turning grip on the bottom of the centre column, which can be removed during fitting of the column to your existing tripod.

The half ball-mounted plate has a male 3/8" screw for attachment to a photo or video head, and a bubble spirit level for added ease of use.

555B for tripods series 055.

556B for tripods series 190.

PAT. PENDING

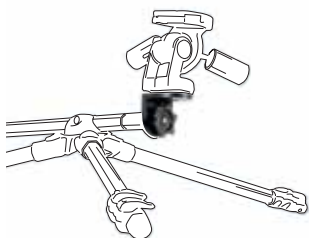

LEVELLING ADAPTER FOR COLUMNS  
 IN HORIZONTAL POSITION **553**

Levelling adapter for columns in horizontal position.



**RUBBER SPIKED FOOT STAINLESS STEEL**  
**055SPK2 · 190SPK2N · 440SPK2 · 441SPK2 · 439SPK2**

Reversible rubber/metal spiked feet (set of 3) supplied with a dedicated fixing tool. The spike is made of a special hard anodised aluminium alloy extremely resistant to corrosion.

055SPK2 for tripods: 055XB, 055XDB and 055XPROB.

190SPK2N for tripods: 190XB and 190XPROB.

440SPK2 for tripods: 055CXPRO4, 190CXPRO3, 190CX3.

441SPK2 for tripods: 055CXPRO3, 055CX3.

439SPK2 for tripod: 190CXPRO4.



**SUCTION CUP/RETRACTABLE SPIKE FEET**  
**055SCK2 · 190SCK2N · 440SCK2 · 441SCK2 · 439SCK2**

A rubber section cup feet (set of 3) with retractable stainless steel spike. The suction cup increases the suitable area of foot of the monopod by almost 20 times, giving much greater stability when needed. The foot can be removed and replaced at will.

055SCK2 for tripods: 055XB, 055XDB and 055XPROB.

190SCK2N for tripods: 190XB and 190XPROB.

440SCK2 for tripods: 055CXPRO4, 190CXPRO3, 190CX3.

441SCK2 for tripods: 055CXPRO3, 055CX3.

439SCK2 for tripod: 190CXPRO4.



**SNOW SHOES 230**

Attach to tripod feet or monopods to provide stability in snow, mud or soft ground (set of 3).

For tripods: 055CX, 055CXPRO, 055XPROB, 055XB, 055XDB, 190CX, 190CXPRO, 190XPROB, 190XB, 190XDB, 458B, 058B and 161MK2B.



**RETRACTABLE SPIKED FOOT ADAPTER 055SPK**

Rubber feet (set of 3) for with retractable metal spike.  
 For tripod: 055CXPRO4.



**RECTANGULAR PLATE ADAPTOR 323**

Supplied with 1/4" camera fixing screws. Fixing 1/4" and 3/8" tread. 200PL rectangular plate included.



**SLIDING PLATE ADAPTOR 357**

Supplied with 1/4" and 3/8" camera fixing screws. Fixing 1/4" and 3/8" thread. 357PLV sliding plate included. Dimension: 140x44x6mm.



**"DOVE TAIL" PLATE ADAPTOR 384**

Supplied with 1/4" and 3/8" camera fixing screws. Fixing 1/4" and 3/8" thread. 384PL and 384PLARCH plates included.



**PLATE ADAPTOR 394**

Supplied with 1/4" and 3/8" camera fixing screws. Fixing 1/4" and 3/8" thread. 410PL plate included. Equipped with 2 built-in spirit levels.



**SLIDING PLATE ADAPTOR 577**

Supplied with 1/4" and 3/8" camera fixing screws. Fixing 1/4" and 3/8" thread. 501PL sliding plate included.



**HEXAGONAL PLATE ADAPTOR 625**

Supplied with 1/4" and 3/8" camera fixing screws. Fixing 1/4" and 3/8" thread. 030 hexagonal plate included. Equipped with 2 built-in spirit levels.



**HEXAGONAL PLATE 030**

030-14 with 1/4" screw.  
030-38 with 3/8" screw.



**ARCH HEXAGONAL PLATE 030ARCH**

Provides alignment for 90° shots with 35mm SLR camera.  
030ARCH-14 with 1/4" screw.  
030ARCH-38 with 3/8" screw.



**HEXAGONAL PLATE 030HAS**

For Hasselblad cameras.  
Supplied with both 1/4" and 3/8" screw.



**LARGE PLATE 030L**

Large 10x10cm plate with 1/4" and 3/8" screw.



**HEXAGONAL PLATE 130**

130-14 with 1/4" screw.  
130-38 with 3/8" screw.



**RECTANGULAR PLATE 200PL**

200PL-14 with 1/4" screw.  
200PL-38 with 3/8" screw.



**ARCH RECTANGULAR PLATE 200PLARCH**

Provides alignment for 90° shots with 35mm SLR camera.  
200PLARCH-14 with 1/4" screw.  
200PLARCH-38 with 3/8" screw.



**UNIVERSAL "ANTI TWIST" SPOTTING SCOPE PLATE 200USS**

This adapter plate has been specifically designed to eliminate unwanted rotation of the spotting scope during viewing. Its universal design means it can be used to mount all makes of spotting scope, no matter what their foot shape (square, rectangular, trapezium), on any Manfrotto two-way head with rapid RC2 connector system. The adapter is made from machine-tooled aluminium with a black anodised finish. In addition to the standard 1/4" screw, it has two grub set screws to lock the spotting scope securely in position.



**"DOVE TAIL" PLATE 384PL**

Supplied with 1/4" and 3/8" camera fixing screws.  
Fixing 1/4" and 3/8" thread.  
384PL and 384PLARCH plates included.



**"DOVE TAIL" ARCH. PLATE 384PLARCH**

Provides alignment for 90° shots with 35mm SLR camera.  
384PLARCH-14 with 1/4" screw.  
384PLARCH-38 with 3/8" screw.



**ACCESSORY PLATE 410PL**

Supplied with 1/4" and 3/8" camera fixing screws.



**PLATE 501PL**

Supplied with 1/4" and 3/8" camera fixing screws.  
Dimension: 86x38x11mm.



**SLIDING PLATE 357PLV**

Supplied with 2x1/4" and 2x3/8" camera fixing screws.  
Dimension: 140x44x6mm.



**PLATE 785PL**

Supplied with 1/4" camera fixing screw.



**ACCESSORY PLATE 400PL**

400PL-LOW = 13mm H.  
400PL-MED = 23mm H.  
400PL-HIG = 42mm H.



Homer, Kenay Peninsula, Alaska.



# CARRYING SOLUTIONS

## Carrying solutions

A complete range of carrying and transportation solutions designed around the tripod head.

With Manfrotto new carrying systems, we've worked from the inside out to invent new contoured bag shapes that fit your kit and offer convenient ways of setting up and breaking down faster, a "space

pad" that lets you shoulder carry your tripod without risking bangs and bruises, an open backpack that keeps your hands free, your tripod protected and weight to a minimum. Whether you want a handle or strap that doesn't even have to be removed from your tripod when you set up a shoot,

or whether you need a protective shell to get your kit safely through baggage hell, we're pleased to say we've got the solution.

With innovative technical features, prime materials and first class construction methods, the quality of all our bags and carrying solutions is up to the high standards you expect from Manfrotto.



# CARRYING SOLUTIONS



**PADDED TRIPOD BAG 120CM MBAG120P**

The largest bag in the range, the MBAG120P is padded to protect your equipment and has the following features:

- Asymmetric tapered shape allows you to store the tripod with the head attached.
- Tripod legs fit comfortably in the narrower end (diameter 20cm) and extra space is allowed for the larger volume of the head at the wider end (diameter 23cm).
- Zip extends down the length of the bag, but also fully opens the top end of the bag.
- Thermoform padding holds the tripod in place in the bag and protects it, especially the head, during transport.
- Inner pocket holds accessories (such as video head pan bars).
- Innovative design and style; ballistic nylon, zips and other materials used are of top quality.
- Can be hand-carried horizontally by the side handle, vertically by the end handle (also useful for storage), or shoulder-carried using the included strap.

**PADDED TRIPOD BAG 100CM MBAG100P**

Same design of MBAG120P different size and without the double positioning carrying handle.

**PADDED TRIPOD BAG 90CM MBAG90P**

Same design of MBAG120P different size and without the double positioning carrying handle.

**PADDED TRIPOD BAG 80CM MBAG80P**

Basically the same as MBAG120P, but smaller, and without the side handle or inner accessory pocket. The MBAG80P is also narrower than the other padded bags. The narrow end measures 13cm diameter, the wide end measures 15cm.

**UNPADDED TRIPOD BAG 80CM MBAG80**

The MBAG80 is an unpadded tripod bag.

- Slightly tapered to provide a better fit for your tripod with attached head. The wider end of the bag accommodates the head without requiring all levers to be removed.
- Zip extends down the length of the bag, but also fully opens the top end of the bag.
- Logo end cap is padded to offer protection to the tripod head, the rest of the bag is unpadded.
- Shoulder strap included (the MBAG80 doesn't have either end or side handle).
- Innovative design and style; ballistic nylon, zips and other materials used are of top quality.

**UNPADDED TRIPOD BAG 70CM MBAG70**

Same as MBAG80, but slightly smaller.

**MINI AIR BAG MBAGD**

The smallest and simplest model in the range, the MBAGD is an unpadded rucksack-style bag for small tripods. It has a bungee cord top opening and adjustable straps. In resistant nylon with printed Manfrotto logo.

Photo tripod model	056	160	222	229	391RC2	400	405	410	460MG	468MG	482	484/484RC2	486/486RC2	488/488RCO	488RC2/488RC4	490/490RC4	804RC	808RC	TWO-WAY HEAD MODEL	128RC/128LP	700RC2	701HDV	TRIPOD WITHOUT HEAD
028B	B	B	B		B	B	B		B					C	B	B	B	B		B			C
055XB, 055XDB, 055PRO4	D	C	D	D			D	D	D	D	D	D	D	D	D	D	D			D	D	D	D
055XPROB, 055CXPRO3, 055CX3	D	C	D	D			D	D	D	D	D	D	D	D	D	D	D			D	D	D	D
058B	A	A	A		A	A	A	D	A					A	A	A	A	A					A
161MK2B																							A
190XB, 190XDB, 190CXPRO4	E	E	E				D	E				E	E	E						E	E	E	E
190CXPRO3, 190CX3, 190XPROB	E	D	E				D	E				E	E	E						E	E	E	E
458B	D	C	D	D			D	D	D	D	D	D	D	D			D			D	D	D	D
475B	B	B	B		B	B	B		B			A	B	B	B	B	B	B		B			C
709B, 709BR																							G
7301YB																							F
7302YB																							F
7303YB																							F
7321YB																							F
7322YB																							F
7322SHYB																							F

- A MBAG 120P
- B MBAG 100P
- C MBAG 90P
- D MBAG 80, MBAG 80P
- E MBAG 70P
- F MBAG D
- G 345BAG



**LONG STRAP 102**

The 102 strap is a basic but convenient way to carry your kit. It has a spring clip that fastens quickly to the steel ring at the shoulder of the tripod, and a closed loop that goes around the feet of the tripod and tightens to grip them securely. Features an adapter for compatibility with all Manfrotto tripods and rubberised fabric for comfort and to avoid the tripod slipping on your shoulder.



**LONG STRAP 440STRAP**

Same as 102, but made with a narrower black rubberised fabric (40mm width instead of 50mm).

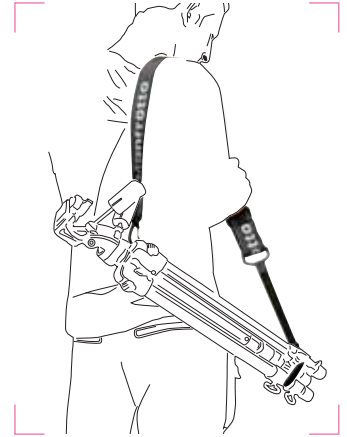

**SHORT STRAP 402**

The 402 is a simple loop strap, with a single spring clip that attaches quickly to the steel ring at the shoulder of your tripod. Features an adapter for compatibility with all Manfrotto tripods. Strap is in grey rubberised fabric for comfort and to avoid the tripod slipping on your shoulder.



**SHORT STRAP 441STRAP**

Same as 402, but made with a narrower black rubberised fabric (40mm width instead of 50mm).





**APRON SUPPORT 166**

Three compartments hang below the column supported by straps above the leg locks. Fits most Manfrotto tripods.



**HAND A LONG 458HL**

Hand carrying strap system for 190 and 055 range of tripods, made of two adjustable straps, one to set the hooks distance when mounted on the 055 or 190 models and the second to bind together their legs to avoid their opening during the transportation.



**QUICK ACTION STRAP 401N**

A quick and easy accessory for carrying your tripod when walking, hiking, cycling or just getting from shoot to shoot. Use the shorter straps to fasten the padded 401N to one of the legs of your tripod, bind the remaining legs together using the longer adjustable quick release straps, sliding the tripod over your shoulder and you're ready to go. The padding helps hold the tripod in place and protects your back from bruises and chaffing. The 401N even stays attached to your tripod when shooting (all you need to do is release the longer quick release straps so you can manoeuvre and position all three legs), so you're always ready to capture the images you want, but also always ready to move off again to the next location.

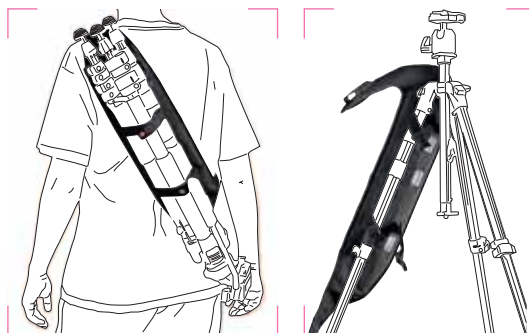

The strap stays attached to your tripod when shooting.



Straps can be removed and custom-positioned to better match the size of your tripod



Connemara, Ireland.

# CAMERA STANDS

## Camera stands

The Manfrotto range of Studio stands offers professionals in the studio rock steady supports for cameras of all formats. Each stand has a column in black anodised extruded aluminium and is available with either a sliding or a geared horizontal

cross arm that can be raised or lowered and moved precisely from side to side to achieve the exact position for the perfect shot. The studio stands have a rigid steel base for stability and incorporate wheels to move them effortlessly

around the studio; a break system locks the stand in the required position. Manfrotto Studio stands with their practical range of accessories are the best solution to your camera support needs.



Key to symbol



Minimum working height



Maximum working height



Stand base dimension



Stand height



Stand weight



Maximum load capacity



Maximum load capacity



## Manfrotto Studio Stand Load Capacity

For safety reasons we have decided to provide two values of load capacity for our Studio Stands, please refer to the drawing above. Higher load value refer to the max load capacity used on the arm of the studio stand when you operate inside the base semicircle (gray area). Lower load value refer to the max load capacity used on the arm of the studio stand when you operate outside the base semicircle (red area). Studio Stand Mini Salon 800 do not mount sliding horizontal arm so the load capacity value refers only to a vertical use.

### Key to symbol

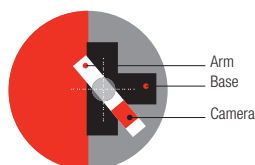

### MINI SALON 800

Sturdy, compact, and surprisingly affordable, the versatile Mini Static can handle cameras from 35mm to 4x5" formats. Ideal for I.D., passport work and portraiture. Pneumatically damped black anodised aluminium column extends from a minimum of 92cm to a height of 162cm. A 3/8" male thread on column top allows direct mounting of head. Cast iron base has two pivoting wheels for easy movement and individual locks. Compatible accessories: 120, 131DB, 131DDB, 820, 828, 844.



### MINI SALON 190 806

Designed for 35mm and medium format cameras, the Mini Salon 190 allows working heights from 56cm to 182cm. Counter-balanced column is black anodised aluminium and is mounted on a heavy cast iron base with two pivoting wheels which lock firmly into place with individual wheel locks. Features smooth operating counter balanced horizontal gear driven crossarm, supplied complete with camera support platform. The crossarm support casting features a built-in accessory tray 20x28cm. Arm length: 80cm. Horizontal arm length: 75cm. Compatible accessories: 120, 131DB, 131DDB, 828, 840, 842, 844.



### SALON 230 809

Just slightly lighter in construction, the Salon 230 has a 8cm diameter black anodised aluminium column with a working height of 221cm provided with an adjust-able counter-balanced sliding horizontal 80cm crossarm. The camera support platform allows movement in a solid angle of 360°. Large sized wheels in the heavy cast base and single pedal control facilitate easy positioning and quick, rock steady locking. The crossarm support casting features a built-in accessory tray 33x28cm. Supplied complete with camera support platform and counter-balanced crossarm. Arm length: 80cm. Horizontal arm length: 70cm. Compatible accessories: 120, 131DB, 131DDB, 820, 822, 824, 826, 828, 834, 844.

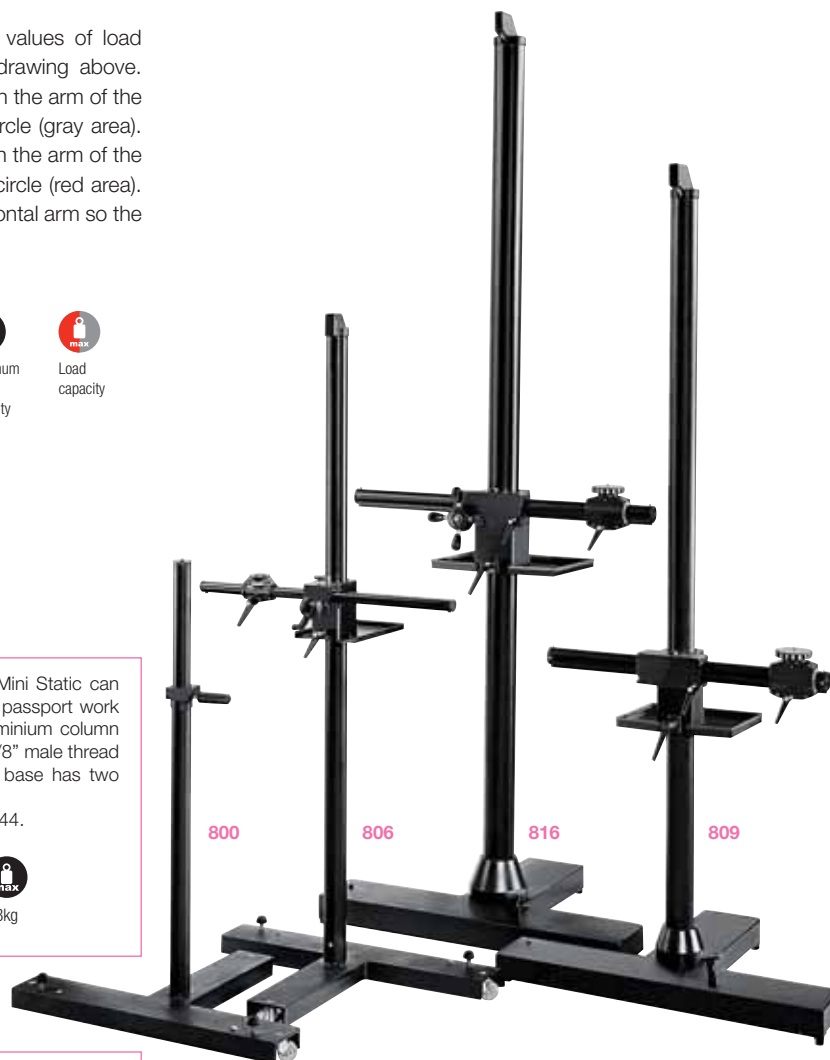

### SUPER SALON 280 816

Our Top-of-the-Line stand, the Super Salon 280 brings the ultimate in stability to new heights in your studio. The rugged column in mounted on a heavy-duty cast "T" base easy to move around because of its smooth-rolling wheels. They can be locked into position with just one step on the single control pedal. The Super Salon 280 has a 10cm diameter black anodised aluminium column and a 100cm horizontal camera arm that travels 62cm. Arm has precise rack and pinion drive, and is accurately counter-balanced to move smoothly up and down. The camera support platform allows movement in a solid angle of 360°. Supplied with counter-balanced crossarm, camera support platform and accessory tray. Arm length: 100cm. Horizontal arm length: 90cm. Compatible accessories: 120, 131DB, 131DDB, 820, 822, 824, 826, 828, 834, 844.

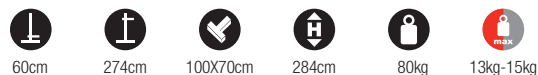

### SUPER SALON 230 816/1

Same as 816 but with 230cm height. Arm length: 100cm. Horizontal arm length: 77cm. Compatible accessories: 120, 131DB, 131DDB, 820, 822, 824, 826, 828, 834, 844.





#### ADAPTER FROM 3/8" TO 1/4" 120

Converts tripod head screw from 3/8" to 1/4".  
For models 800, 806, 809, 816 and 816/1.



#### ACCESSORY ARM 131DB

Mounts on any column with 3/8" thread, this side arm allows positioning of two heads on a 90° perpendicular angle.  
For models 800, 806, 809, 816 and 816/1.

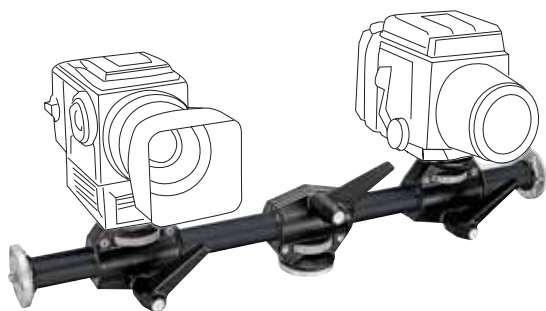

#### ACCESSORY ARM FOR 4 HEADS 131DDB

Similar to the 131DB with the addition of two positional head mounts on the side arm allowing the possible mounting of four heads.  
For models 800, 806, 809, 816 and 816/1.



#### 45CM COLUMN EXTENSION 820

Adds 45cm to crossarm. Mounts directly into arm and accepts any camera platform.  
For models 800, 809, 816 and 816/1.



#### LOW ANGLE ADAPTER ARM 822

Connection bracket between the horizontal arm and the column extension which permits to increase or decrease the shooting point compared to the horizontal arm.  
For models 809, 816 and 816/1.

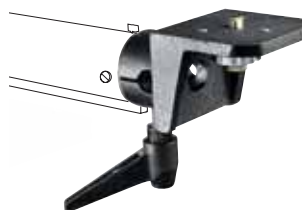

#### 90° ADDITIONAL REVOLVING HEAD 824

With 3/8" threaded fitting.  
For models 809 and 816.

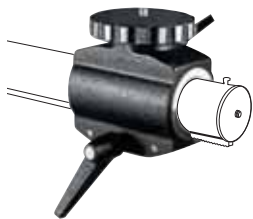

#### ADDITIONAL CAMERA HOLDER **826**

This optional camera holder allows to put a second camera on the horizontal arm of your Studio Stand.  
For models 809, 816 and 816/1.



#### HORIZONTAL BRACKET WITH TWO CONNECTIONS **828**

Allows two camera mounting positions.  
For models 800, 806, 809, 816 and 816/1.



#### ADDITIONAL COUNTER-WEIGHT **834**

2kg additional counter-weight. To be screwed to the counter-weight inside the column.  
For models 809, 816 and 816/1.

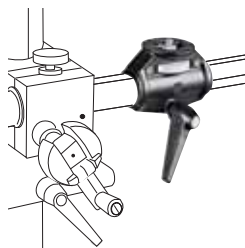

#### ADDITIONAL CAMERA MOUNT **840**

This optional camera holder allows to put a second camera on the horizontal arm of your Studio Stand.  
For model 806.



#### 90° CAMERA MOUNT **842**

90° additional revolving head.  
For model 806.



#### UTILITY TRAY 29X29CM **844**

Optional accessory tray makes it easy to keep meters and extra film holders at arms length.  
For models 800, 806, 809, 816 and 816/1.

## Corporate Social Responsibility

# CORPORATE SOCIAL RESPONSIBILITY

### CSR

Corporate Social Responsibility is an essential value for Manfrotto. We consider Corporate Responsibility as a significant way to employ our people energy and passion in order to generate a meaningful change. For this reason we are involved in several projects to support the fundamental human rights, particularly for kids, and to define specific programs aimed to minimize

the environmental impact. To support these causes we actively provide funding or equipment to the organizations we sustain. One of our main projects, started in 2007, is to sponsor the set-up and touring exhibition “Acholi un popolo da amare”, about Acholi refugee camps in Northern Uganda, a country that suffered 20 years of civil war. This

exhibition has two objectives: the first one is to promote the further knowledge of the situation of this African tribe, and the second one is to raise funds to realize important humanitarian interventions in the area. Moreover we are supporting an international program run by the Dottor Clown Italia association, which aim is to keep suffering people amused during hospitalization.

# RE S P O N S I B I L I T Y



We believe that, in order to succeed in our job, we also need to share principles and values that define our identity, meaning also a clear responsibility for the impact of our activities on employees, customers, shareholders, communities and the environment. A good relationship among these players - based on integrity, transparency and honesty - is very important to improve the quality of our lives.

In our everyday approach we adopt policies marked by fairness in order to improve outward transparency for our shareholders. Because all human activity has an inevitable impact on the planet and can be contained and mitigated through research and the adoption of cutting-edge solutions, we have opted to use electrical energy from renewable sources for our most important plants.

We operate through certificates that are issued in the country where the production of electrical energy from renewable sources takes place. This encourages the development of a global renewable energy sources market and therefore promotes the spread of new production capacity. Social responsibility commitment is part of our company philosophy, an important part of our growth.

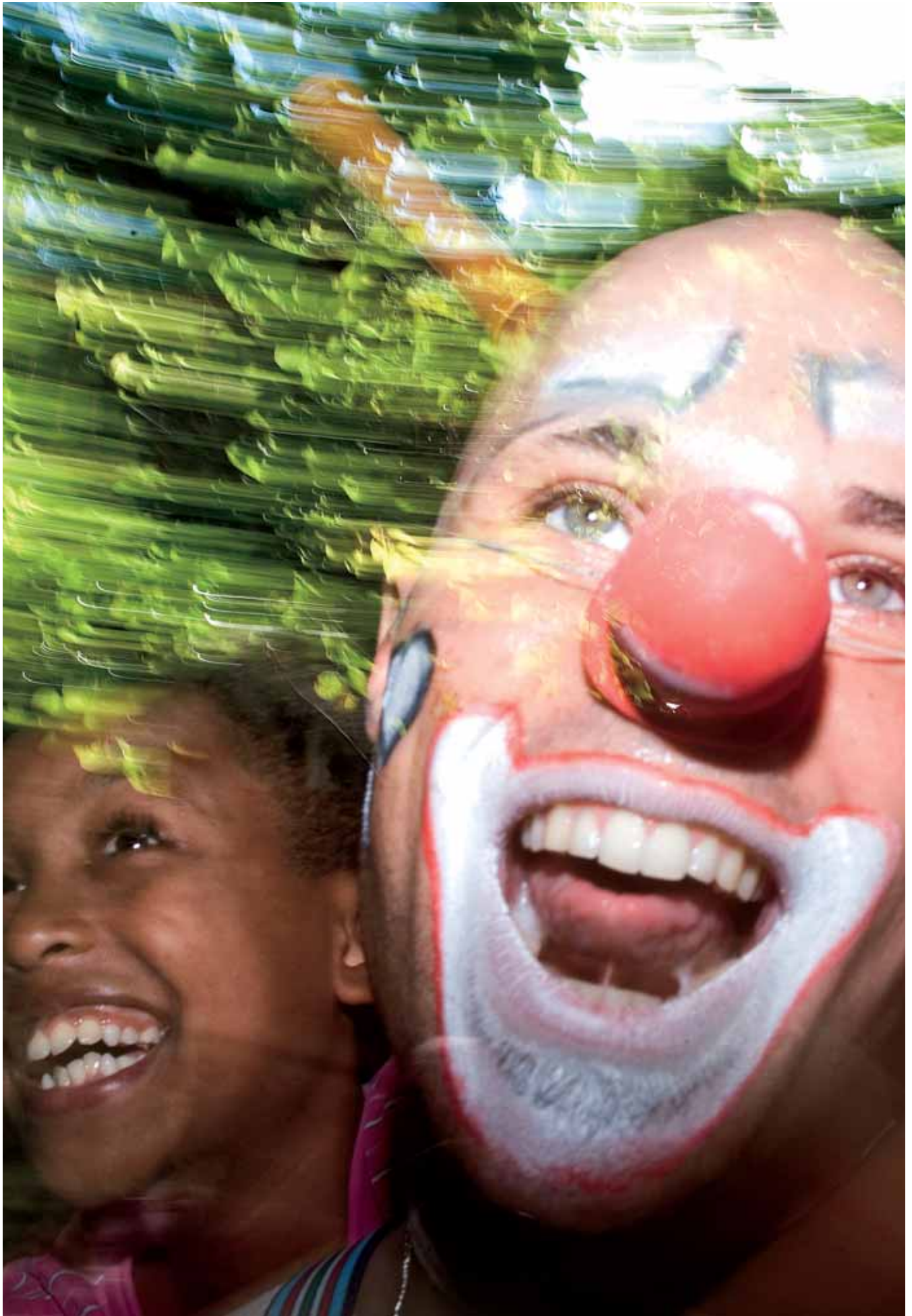













## Summary chart

TRIPODS														
		TECHNICAL SPECIFICATIONS							FEATURES					
MODELS	PAG													
161MK2B	15	105cm	44cm	267cm	242cm	7.95kg	20kg	114/181B					X	40mm
058B	16	94cm	44cm	217cm	191cm	6.15kg	12kg	127/127VS 181B					X	30mm
475B	17	80cm	43cm	188cm	162cm	4.3kg	12kg	114/181B					X	35mm
028B	17	82cm	77cm	227cm	179cm	4.15kg	12kg	181B					X	25mm
458B	19	64cm	10cm	156cm	131cm	2.4kg	8kg						X	28mm
055CXPRO3	21	65cm	11.5cm	175cm	140cm	1.65kg	8kg	127/127VS		X				29.2mm
055CXPRO4	22	54.5cm	11.5cm	170cm	135.5cm	1.70kg	8kg	127/127VS		X				29.2mm
055CX3	22	61.5cm	6.5cm	177cm	136cm	1.78kg	8kg	127/127VS		X				29.2mm
055XPROB	23	65.5cm	10cm	178.5cm	142cm	2.4kg	7kg	127/127VS				X		29.4mm
055XB	24	61cm	8cm	178cm	137.5cm	2.3kg	7kg	127/127VS				X		29.4mm
055XDB	24	61cm	48cm	178cm	137.5cm	2.1kg	7kg	127/127VS				X		29.2mm
190CXPRO3	25	58cm	8cm	146cm	122cm	1.29kg	5kg	127/127VS		X				24.8mm
190CXPRO4	26	50cm	8cm	146cm	122cm	1.34kg	5kg	127/127VS		X				24.8mm
190CX3	27	55cm	6cm	146cm	119cm	1.32kg	5kg	127/127VS		X				24.8mm
190XPROB	28	57cm	8.5cm	146cm	122cm	1.8kg	5kg	127/127VS				X		25mm
190XB	28	53.5cm	8cm	146cm	118.5cm	1.8kg	5kg	127/127VS				X		25mm
190XDB	29	53.5cm	35cm	146cm	118.5cm	1.6kg	5kg	127/127VS				X		25mm
7301YB	31	51cm	36cm	143cm	126cm	1.67kg	3.5kg		200PL				X	26mm
7302YB	32	51cm	36cm	144cm	126cm	1.47kg	3.5kg		200PL				X	26mm
7303YB	33	48.5cm	34.5cm	142cm	124cm	1.34kg	3.5kg		200PL				X	26mm
7321YB	34	49cm	35cm	142cm	123cm	1.27kg	2.5kg		785PL				X	22mm
7322YB	35	48cm	34cm	141cm	122cm	1.09kg	2kg						X	22mm
7322SHYB	35	42cm	31.5cm	119cm	100cm	1.02kg	2kg						X	22mm

MONOPODS													
		TECHNICAL SPECIFICATIONS					FEATURES						
MODELS	PAG												PATENTED
334B	73	68cm	166cm	049kg	8kg		X	22mm					X
685B	73	74.8cm	170cm	0.8kg	8kg		X	22mm			X		X
680B	73	51cm	154cm	0.83kg	10kg		X		35.4mm				
681B	73	67cm	161cm	0.78kg	12kg		X	35.4mm					
679B	74	64cm	162cm	0.6kg	10kg		X	29.4mm					
682B	74	74cm	172cm	1.1kg	12kg		X	35.4mm					X
695CX	74	47.5cm	160.5cm	0.60kg	5kg	X				29.2mm			
694CX	74	54cm	165cm	0.59kg	5kg	X			29.2mm				
776YB	75	48cm	152.5cm	0.33kg	4.5kg		X	26mm					X



FEATURES						SUGGESTED CAMERAS						
					PATENTED							
	X								X	X	X	161MK2B
	X								X	X	X	058B
	X								X	X	X	475B
	X								X	X	X	028B
			X		X			X	X	X		458B
X				X	X			X	X	X		055CXPRO3
X				X	X			X	X	X		055CXPRO4
		X						X	X	X		055CX3
X				X	X			X	X	X		055XPROB
		X						X	X	X		055XB
								X	X	X		055XDB
X				X	X		X	X	X			190CXPRO3
X				X	X		X	X	X			190CXPRO4
		X					X	X	X			190CX3
X				X	X		X	X	X			190XPROB
		X					X	X	X			190XB
							X	X	X			190XDB
						X	X	X				7301YB
						X	X	X				7302YB
						X	X	X				7303YB
						X	X	X				7321YB
						X	X	X				7322YB
						X	X	X				7322SHYB

# Summary chart

HEADS																
		TECHNICAL SPECIFICATIONS								FEATURES						
MODELS	PAG															
400	41	16cm	2.6kg	10kg	400PL-LOW 400PL-MED 400PL-HG	Pan 360°	-90°+30°	-7.5°+7.5°		X						
405	42	16cm	1.6kg	7.5kg	410PL	Pan 360°	-90°+30°	-90°+30°		X		X	X			
410	43	13cm	1.22kg	5kg	410PL	Pan 360°	-90°+30°	-90°+30°		X		X	X			
804RC2	45	12cm	0.79kg	4kg	200PL	Pan 360°	-90°+30°	-90°+30°			X		X			
808RC4	45	15.6cm	1.42kg	8kg	410PL	Pan 360°	-90°+30°	-90°+30°		X		X	X			
460MG	46	10.5cm	0.43kg	3kg	200PL-14	Pan 360°	-90°+30°	-180°+30°	X				X			
056	46	10cm	0.5kg	3kg		Pan 360°	-30°+180°	-180°+30°		X						
391RC2	47	10cm	0.7kg	5kg	200PL-14	Pan 360°	-75°+90°	-90°+90°		X			X			
229	47	16cm	1.9kg	12kg	030-14	Pan 360°	-25°+90°	-90°+30°		X		X	X			
468MGRC2	49	12cm	0.65kg	10kg	200PL-14	Pan 360°		-90°+90°	X				X	X	X	X
468MG	50	13cm	0.65kg	16kg		Pan 360°		-90°+90°	X						X	X
468MGRC0	50	13.5cm	0.84kg	16kg	030-14	Pan 360°		-90°+90°	X			X	X	X	X	X
468MGRC3	50	12cm	0.8kg	16kg	357PLV	Pan 360°		-90°+90°	X				X	X	X	X
468MGRC4	51	12cm	0.73kg	16kg	410PL	Pan 360°		-90°+90°	X			X	X	X	X	X
468MGRC5	51	12cm	0.74kg	12kg	501PL	Pan 360°		-90°+90°	X				X	X	X	X
490	52	14cm	1.05kg	12kg		Pan 360°		-90°+90°		X					X	
490RC4	52	13.7cm	1.12kg	12kg	410PL	Pan 360°		-90°+90°		X		X	X	X		
488	53	11.2cm	0.56kg	8kg		Pan 360°		-90°+90°		X					X	
488RC2	53	10.8cm	0.67kg	8kg	200PL-14	Pan 360°		-90°+90°		X			X	X		
488RC4	53	11.5cm	0.8kg	8kg	410PL	Pan 360°		-90°+90°		X		X	X	X		
488RC0	54	13.4cm	0.83kg	8kg	030-14	Pan 360°		-90°+90°		X		X	X	X		
486	54	9.2cm	0.38kg	6kg		Pan 360°		-90°+90°		X						
486RC2	54	10cm	0.46kg	6kg	200PL-14	Pan 360°		-90°+90°		X			X			
484RC2	55	9.5cm	0.32kg	4kg	200PL-14	Pan 360°		-90°+90°		X			X			
484	55	7.5cm	0.25kg	4kg		Pan 360°		-90°+90°		X						
482	55	5.8cm	0.09kg	2kg		Pan 360°		-90°+90°		X						
322RC2	57	10.3cm	0.7kg	5kg	200PL-14	Pan 360°	-90°+90°	-3°+90°		X		X	X	X		
222	59	21cm	0.78kg	2.5kg	200PL-14	Pan 360°		-90°+90°		X			X	X		
303SPH	62	32cm	2kg	4kg	357PLV					X						
303PLUS	63	31.3cm	2.2kg	5kg						X						
303	64	31.3cm	1.65kg	5kg						X						
300N	65	6.3cm	0.52kg	14kg						X						
128LP	67	11cm	1kg	4kg		Pan 360°		-90°+90°		X						
128RC	67	11.5cm	1kg	4kg	200PL-14	Pan 360°		-60°+90°		X			X			
700RC2	67	9.6cm	0.52kg	2.5kg	200PL-14	Pan 360°		-75°+90°		X			X			
701HDV	67	9.5cm	0.83kg	4kg	501PL	Pan 360°		-60°+90°		X			X			

FEATURES			SUGGESTED CAMERAS						SUGGESTED USES							
		X					X	X	X		X		X	X		400
		X					X	X	X		X		X	X		405
		X					X	X	X		X		X	X		410
	X	X		X	X	X	X		X	X	X		X	X		804RC2
	X	X		X	X	X	X		X	X	X		X	X		808RC4
		X		X	X	X	X		X	X	X		X	X		460MG
		X		X	X	X	X		X	X	X		X	X		056
				X	X	X	X		X	X	X		X	X		391RC2
		X		X	X	X	X		X	X	X		X	X		229
					X	X			X	X	X	X				468MGRC2
					X	X			X	X	X	X				468MG
					X	X			X	X	X	X				468MGRC0
					X	X			X	X	X	X				468MGRC3
					X	X			X	X	X	X				468MGRC4
					X	X			X	X	X	X				468MGRC5
			X	X	X	X			X	X	X	X				490
			X	X	X	X			X	X	X	X				490RC4
			X	X	X	X			X	X	X	X				488
			X	X	X	X			X	X	X	X				488RC2
			X	X	X	X			X	X	X	X				488RC4
			X	X	X	X			X	X	X	X				488RC0
			X	X	X	X			X	X	X	X				486
			X	X	X	X			X	X	X	X				486RC2
			X	X	X	X			X	X	X	X				486RC2
			X	X	X	X			X	X	X	X				484
			X	X	X	X			X	X	X	X				482
			X	X	X	X			X	X	X	X				322RC2
			X	X	X	X			X	X	X	X				222
		X			X	X	X	X			X			X		303SPH
		X			X	X	X	X			X			X		303PLUS
		X			X	X	X	X			X			X		303
					X	X	X	X			X			X		300N
X				X	X	X						X			X	128LP
X				X	X	X						X			X	128RC
				X	X	X						X			X	700RC2
X				X	X	X						X			X	701HDV

Art. N°	Description	Page
028B	TRIMAN TRIPOD	17
030	HEXAGONAL PLATE	101
030-14	HEXAGONAL PLATE WITH 1/4" SCREW	101
030-38	HEXAGONAL PLATE WITH 3/8" SCREW	101
030ARCH	ARCH HEXAGONAL PLATE	101
030ARCH-14	ARCH HEXAGONAL PLATE WITH 1/4" SCREW	101
030ARCH-38	ARCH HEXAGONAL PLATE WITH 3/8" SCREW	101
030AT	ANTI THEFT PLATE	92
030HAS	HEXAGONAL PLATE	101
030L	LARGE PLATE	101
035C	SUPER CLAMP	85
035BN	BINOCULAR SUPER CLAMP	86
037	CAMERA MOUNTING STUD	91
055CCSB	SHORT COLUMN	97
055CX3	3 SECTION CARBON FIBER/MAGNESIUM TRIPOD	22
055CXPRO3	3 SECTION CARBON FIBER/MAGNESIUM TRIPOD	21
055CXPRO4	4 SECTION CARBON FIBER/MAGNESIUM TRIPOD	22
055XB	CLASSIC TRIPOD	24
055XDB	BASIC TRIPOD	24
055LAA	LOW ANGLE ADAPTER FOR 055 RANGE	98
055XPROB	PRO TRIPOD	23
055SCK2	SUCTION CUP/RETRACTABLE SPIKE FEET	99
055SPK	RETRACTABLE SPIKED FOOT ADAPTER	99
055SPK2	RUBBER/SPIKED FOOT STAINLESS STEEL	99
056	3D JUNIOR HEAD	46
058B	TRIAUT TRIPOD	16
080	MONOPOD BELT POUCH	75
088LBP	SMALL ADAPTOR	91
102	LONG STRAP	108
114	VIDEO DOLLY	81
120	ADAPTER FROM 3/8" TO 1/4"	114
120DF	JOINT FOR ARMS	91
127	BASIC DOLLY	81
127VS	PORTABLE DOLLY	81
128LP	MICRO VIDEO HEAD	69
128RC	MICRO VIDEO HEAD BLACK	69
130	HEXAGONAL PLATE	101
130-14	HEXAGONAL PLATE WITH 1/4" SCREW	101
130-38	HEXAGONAL PLATE	101
131DB	ACCESSORY ARM	114
131DDB	ACCESSORY ARM FOR 4 HEADS	114
131TC	TABLE CENTRE POST	89
143RC	MAGIC ARM WITH QUICK RELEASE PLATE	85
143S	FLASH SHOE	91
155RC	DOUBLE BALL TILT HEAD	86
161MK2B	SUPER PRO TRIPOD	15
165	TRIPOD SPREADER	81
166	APRON SUPPORT	109
181B	FOLDING AUTO DOLLY	81
183	MONITOR/PROJECTOR HOLDER	89
190CCSB	SHORT COLUMN	97
190CX3	3 SECTION CARBON FIBER/MAGNESIUM TRIPOD	27
190CXPRO3	3 SECTION CARBON FIBER/MAGNESIUM TRIPOD	25
190CXPRO4	4 SECTION CARBON FIBER/MAGNESIUM TRIPOD	26
190XB	ALU TRIPOD	28
190XDB	ALU TRIPOD	29
190LAA	LOW ANGLE ADAPTER FOR 190 RANGE	98

Art. N°	Description	Page
190XPROB	PRO TRIPOD	28
190SCK2N	SUCTION CUP/RETRACTABLE SPIKE FEET	99
190SPK2N	RUBBER/SPIKED FOOT STAINLESS STEEL	99
200PL	RECTANGULAR PLATE	102
200PL-14	RECTANGULAR PLATE WITH 1/4" SCREW	102
200PL-38	RECTANGULAR PLATE WITH 3/8" SCREW	102
200PLARCH	ARCH. RECTANGULAR PLATE	102
200PLARCH-14	ARCH. RECTANGULAR PLATE WITH 1/4" SCREW	102
200PLARCH-38	ARCH. RECTANGULAR PLATE WITH 3/8" SCREW	102
200USS	UNIVERSAL "ANTI TWIST" SPOTTING SCOPE PLATE	102
208	CAMERA MOUNTING ADAPTOR	91
208HEX	CAMERA MOUNTING ADAPTOR HEXAGONAL PIN	91
222	BLACK GRIP ACTION BALL HEAD	59
229	3D PRO HEAD	47
230	SNOW SHOES	99
233B	CAMERA BRACKET	89
234	MONOPOD TILT TOP	75
234RC2	MONOPOD QUICK RELEASE TILT TOP	75
236	SPIKED FOOT FOR MONOPOD	75
241	PUMP CUP	90
241FB	PUMP CUP WITH FLAT BASE	90
241V	CAMERA SUCTION MOUNT	90
243	CAR WINDOW POD	86
244RC	VARIABLE FRICTION ARM WITH QUICK RELEASE PLATE	85
248	METZ FLASH SCREW	91
262	NIKON FLASH ADAPTOR	91
269HDB-3U	LOOK OUT STAND	93
273	SURVEY ADAPTOR	92
293	TELEPHOTO LENS SUPPORT	88
296	PHOTO CLAMP	86
300N	PAN ROTATION UNIT	65
303	PAN HEAD	64
303PLUS	PRECISION PAN HEAD	63
303SPH	MULTI ROW PAN HEAD	62
303SPHUK	UPGRADE KIT: CONVERTS 302 INTO 303SPH HEAD	62
322RA	ADDITIONAL CAMERA PLATE FOR 322RC2	58
322RC2	HORIZONTAL GRIP ACTION BALL HEAD	57
322RS	ELECTRONIC SHUTTER RELEASE KIT	58
322RSM	CABLE SHUTTER RELEASE KIT	58
323	RECTANGULAR PLATE ADAPTOR	100
324	SURVEY PLATE ADAPTOR	92
330B	MACRO BRACKET FLASH SUPPORT	89
331	MONOPOD SUPPORT	77
334B	AUTOMATIC MONOPOD	73
337	HOT SHOE TWO AXIS BUBBLE LEVEL	97
338	LEVELLING BASE	97
340	ELBOW BRACKET	88
341	JUNIOR ELBOW BRACKET	88
345	TABLE TOP TRIPOD KIT	87
349	COLUMN CLAMP	86
355	TABLE SUPPORT	88
356	WALL SUPPORT	88
357	SLIDING PLATE ADAPTOR	100
357PLV	SLIDING PLATE	103
358	SURVEY PLATE ADAPTOR ACCESSORY PLATE	92
359	LONG LENS CAMERA SUPPORT	88
361	SHOULDER BRACE FOR MONOPOD	77



Art. N°	Description	Page	Art. N°	Description	Page
380	LEG WARMERS	92	577	SLIDING PLATE ADAPTOR	100
381	LEG WARMERS	92	625	HEXAGONAL PLATE ADAPTOR	100
384	"DOVE TAIL" PLATE ADAPTOR	100	627	BASIC PANORAMIC HEAD ADAPTER	97
384PL	"DOVE TAIL" PLATE	102	676SC2	SUCTION CUP/RETRACTABLE SPIKE FOOT	76
384PLARCH	"DOVE TAIL" ARCH. PLATE	102	676SP2	RUBBER/SPIKE FOOT STAINLESS STEEL	76
384PLARCH-14	"DOVE TAIL" ARCH. PLATE WITH 1/4" SCREW	102	677SCN	SUCTION CUP/RETRACTABLE SPIKE FOOT	76
384PLARCH-38	"DOVE TAIL" ARCH. PLATE WITH 3/8" SCREW	102	677SPN	RUBBER/SPIKE FOOT	76
385	AIR CUSHIONED TABLE CENTRE POST	89	678	UNIVERSAL FOLDING BASE	77
386BC	NANO CLAMP	86	679B	MONOPOD	74
391RC2	3D PRO HEAD	47	680B	COMPACT MONOPOD	73
393	LONG LENS MONOPOD BRACKET	76	681B	PROFESSIONAL MONOPOD	73
394	PLATE ADAPTOR	100	682B	SELF-STANDING PRO MONOPOD	74
400	GEARED HEAD	41	685B	NEOTEC PRO PHOTO MONOPOD	73
400PL	ACCESSORY PLATE	103	695SC2	SUCTION CUP/RETRACTABLE SPIKE FOOT	76
401N	QUICK ACTION STRAP	109	694CX	4 SECTION CARBON FIBER MONOPOD	74
402	SHORT STRAP	108	695CX	5 SECTION CARBON FIBER MONOPOD	74
405	PRO GEARED HEAD	42	695SP2	RUBBER/SPIKED FOOT STAINLESS STEEL	76
410	JUNIOR GEARED HEAD	43	700RC2	BLACK MINI VIDEO HEAD	68
410PL	ACCESSORY PLATE	103	709B	BLACK DIGI TABLE TRIPOD	87
430	ACCESSORY LONG PLATE	92	709BR	SILVER BRIGHT DIGI TABLE TRIPOD	87
438	BALL CAMERA LEVELLER	97	701HDV	PRO FLUID VIDEO MINI HEAD	67
439SCK2	SUCTION CUP/RETRACTABLE SPIKE FEET	99	776YB	M .Y MONOPOD	75
439SPK2	RUBBER SPIKE FOOT STAINLESS STEEL	99	785PL	PLATE	103
440SCK2	SUCTION CUP/RETRACTABLE SPIKE FEET	99	800	MINI SALON	113
440SPK2	RUBBER/SPIKED FOOT STAINLESS STEEL	99	804RC2	BASIC PAN TILT HEAD WITH QUICK RELEASE PLATE	45
440STRAP	LONG STRAP	108	806	MINI SALON 190	113
441SCK2	SUCTION CUP/RETRACTABLE SPIKE FEET	99	808RC4	STANDARD 3-WAY HEAD WITH QUICK RELEASE PLATE	45
441SPK2	RUBBER SPIKE FOOT STAINLESS STEEL	99	809	SALON 230	113
441STRAP	SHORT STRAP	108	814	MINI HYDROSTATIC ARM	85
449SC2	SUCTION CUP/RETRACTABLE SPIKE FEET	76	816	SUPER SALON 280	113
449SP2	RUBBER SPIKE FOOT STAINLESS STEEL	76	816/1	SUPER SALON 230	113
454	MICRO POSITIONING PLATE	90	819	SMALL HYDROSTATIC ARM	85
458B	NEOTEC PRO PHOTO TRIPOD	19	820	45CM COLUMN EXTENSION	114
458HL	HAND A LONG	109	822	LOW ANGLE ADAPTER ARM	114
460MG	3D MAGNESIUM HEAD	46	823	MEDIUM HYDROSTATIC ARM	85
468MG	HYDROSTATIC BALL HEAD	50	824	90° ADDITIONAL REVOLVING HEAD	114
468MGRC0	HYDROSTATIC BALL HEAD WITH RC0 RAPID CONNECT SYSTEM	50	826	ADDITIONAL CAMERA HOLDER	114
468MGRC2	HYDROSTATIC BALL HEAD WITH RC2 RAPID CONNECT SYSTEM	49	828	HORIZONTAL BRACKET WITH TWO CONNECTIONS	114
468MGRC3	HYDROSTATIC BALL HEAD WITH RC3 RAPID CONNECT SYSTEM	50	834	ADDITIONAL COUNTER-WEIGHT	114
468MGRC4	HYDROSTATIC BALL HEAD WITH RC4 RAPID CONNECT SYSTEM	51	840	ADDITIONAL CAMERA MOUNT	114
468MGRC5	HYDROSTATIC BALL HEAD WITH RC5 RAPID CONNECT SYSTEM	51	842	90° CAMERA MOUNT	114
475B	PRO GEARED TRIPOD	17	844	UTILITY TRAY 29X29 CM	114
482	MICRO BALL HEAD	55	7301YB	M .Y TRIPOD WITH 3-WAY HEAD	31
484	MINI BALL HEAD	55	7302YB	M .Y TRIPOD WITH BALL HEAD	32
484RC2	MINI BALL HEAD WITH RC2 RAPID CONNECT SYSTEM	55	7303YB	M .Y TRIPOD WITH BALL HEAD	33
486	COMPACT BALL HEAD	54	7321YB	M .Y TRIPOD WITH 3-WAY HEAD	34
486RC2	COMPACT BALL HEAD WITH RC2 RAPID CONNECT SYSTEM	54	7322YB	M .Y TRIPOD WITH BALL HEAD	35
488	MIDI BALL HEAD	53	73222SHYB	M .Y TRIPOD WITH BALL HEAD	35
488RC0	MIDI BALL HEAD WITH RC0 RAPID CONNECT SYSTEM	54	MBAGD	MINI AIR BAG	107
488RC2	MIDI BALL HEAD WITH RC2 RAPID CONNECT SYSTEM	53	MBAG70	UNPADDED TRIPOD BAG 70CM	107
488RC4	MIDI BALL HEAD WITH RC4 RAPID CONNECT SYSTEM	53	MBAG80	UNPADDED TRIPOD BAG 80CM	107
490	MAXI BALL HEAD	52	MBAG80P	PADDED TRIPOD BAG 80CM	107
490RC4	MAXI BALL HEAD WITH RC4 RAPID CONNECT SYSTEM	52	MBAG90P	PADDED TRIPOD BAG 90CM	107
501PL	PLATE	103	MBAG100P	PADDED TRIPOD BAG 100CM	107
553	LEVELLING ADAPTER FOR COLUMNS IN HORIZONTAL POSITION	98	MBAG120P	PADDED TRIPOD BAG 120CM	107
555B	LEVELLING CENTRE COLUMN	98	WMANTOOL	TOOL KIT	88
556B	LEVELLING CENTRE COLUMN	98			

CAMERA TRIPODS MONOPOD

CARRY HEADS SCENES

ALTERNATIVE MONOPODS SUPPORT

ACCESSORY DOLLIES

ALTERNATIVE SUPPORTS

DO ACCESSORIES

HEADS CARRYING SOLUTIONS

TRIPODS CAMERA STANDS

## Key to symbols



Closed length



Minimum height



Maximum height



Maximum height with extended center column



Footprint diameter



- Maximum load capacity
- All stated maximum load capacity are measured centred on the tripod/head mounting point.



Weight



Head height



Plate supplied with the head



Suggested dolly

### CARBON FIBER

The Manfrotto's carbon fiber tubes reach the highest quality standards and performance. They provide an outstanding rigidity and lightness. Carbon fiber tubes can be produced with very different processes, generating products with different levels of quality. Manfrotto chose to reach the maximum quality using 100% carbon fiber and the pull winding technology. This production process is able to maximize performance, resistance and reliability.



### MAGNESIUM

Magnesium is a light metal, with two thirds the density of aluminium. It's a good material for having good mechanical properties reducing the weight in medium volume components and parts



### ALUMINIUM

One of the most popular material for light weight structures. The Manfrotto's aluminium is selected with the highest quality criteria in order to provide the required performance in terms of reliability, lightness and stability.



### ADAPTO

The polymeric parts of the Manfrotto products are made with the highest quality standards for providing the required mechanical resistance and reliability.



### DIAMETER OF LEG 3 SECTIONS

Two of the most important parameters affecting dimensions and performances.



### DIAMETER OF LEG 4 SECTIONS



### DIAMETER OF LEG 5 SECTIONS



### Q90 COLUMN

This ingenious system allows the user to move the central column from vertical to horizontal position in just seconds without having to disassemble the column.



### GEARED COLUMN

The control system for safely moving heavy loads on professional tripods.



### LOW ANGLE ADAPTER

The useful accessory for reducing the minimum height of the tripod.



### NEOTEC TECHNOLOGY

The innovative Manfrotto's technology to quickly set up and close the tripod legs without using levers or knobs.



### LEVELLING BUBBLE

The basic but essential way to place your tripod/head system in the right position



### QUICK RELEASE

The head plate allows to quickly fix and release the camera without risks of vibration or slipping.



### BALL FRICTION

The friction of the ball head can be adjusted to safely control the camera movement.



### HYDRO TECHNOLOGY

The Manfrotto's hydraulic mechanism for having the best blocking system on ball heads. Using the hydrostatic laws, Manfrotto has designed a very efficient system for loads up to 16Kilos. With a fingertip control, the camera can be locked in a secure position giving the impression it has become a single fixed object with the head.



### FLUID CARTRIDGE

The system for having smooth and regular movements when using video cameras. A special fluid cartridge is used in order to avoid direct friction between surfaces, providing better control and constant movements. A required technology for heads and monopods coupled with video cameras.



### COUNTERBALANCE SPRING

Special springs can be used inside heads in order to handle more comfortably heavier camera loads. These springs can be turned off in case normal operation is required.



### MICRO ADJUSTMENT

Gearred system for a very fine adjustment of the camera position.



PATENTED





# Manfrotto

**Lino Manfrotto + Co., s.p.a.**

Via Sasso Rosso 19  
I-36061 Bassano del Grappa (VI) Italia  
Tel +39 0424 555 855  
Fax +39 0424 808 999  
[www.manfrotto.com](http://www.manfrotto.com)

**Credits**

Pages 36, 78, 94, 104, 117, 118, 119 photos by Veronica Wiplinger  
Pages 70, 110 photos by Daniele Mosconi  
Page 82 photo by Ivano Bosio  
Page 10 photo by Silvia Bonanno

Product photography: Roberto Bigano/Multistudio

Concept: Claim adv

Whilst every effort has been made to ensure that the information contained within this catalog is correct, Lino Manfrotto + Co., s.p.a. accepts no liability for errors or omissions. Technical specifications and data are provided for guidance only. All rights are strictly reserved. Products shown in this catalog are protected by international patents, while copying this publication (in whole or in part) without written consent from Lino Manfrotto + Co., s.p.a. is strictly forbidden and punishable by law. Because we constantly aim to improve our products, we reserve the right to amend or alter at any time and without prior notice the specifications of any item detailed in this publication.

**ISSUE CODE LNORD09,G - ISSUE NUMBER N°1 - 09/08**